

2022 INFINITI INTOUCH OWNER'S MANUAL



I N F I N I T I .

For your safety, read carefully and keep in this vehicle.

INFINITI CONSUMER AFFAIRS DEPARTMENT

For assistance or inquiries about the INFINITI warranty, service or general questions, contact the INFINITI Consumer Affairs Department at:

For U.S. customers

1-800-662-6200

For Canadian customers

1-800-361-4792

INFINITI NAVIGATION SYSTEM HELPDESK CONTACT INFORMATION

For assistance or inquiries about the Navigation system, contact the INFINITI NAVIGATION SYSTEM HELPDESK at:

- ADDRESS: P.O. Box 1588 Orem, UT 84059-992
- E-MAIL: infiniti-navi-info@here.com

For U.S. customers

WEB SITE: www.InfinityNavigation.com

PHONES: 1-888-362-8837

HOURS: Monday – Friday: 8:00 AM – 8:00 PM (Eastern Time) and Saturday: 10:00 AM – 6:00 PM (Eastern Time)

For Canadian customers

WEB SITE: www.infiniti.ca.

PHONES: 1-800-361-4792

HOURS: Monday – Friday: 8:00 AM – 8:00 PM (Eastern Time) and Saturday: 10:00 AM – 6:00 PM (Eastern Time)

INFINITI INTOUCH™ SYSTEM HELPDESK CONTACT INFORMATION

For assistance or inquires about INFINITI InTouch™ system, contact INFINITI Owner Services helpdesk at:

- PHONES: 1-855-444-7244
- E-MAIL: infinitiownerservices@infiniti.com

For U.S. customers

WEB SITE: www.infinitiusa.com/intouch/support

For Canadian customers

WEB SITE:

English: www.infiniti.ca/infinitiintouch

French: www.infiniti.ca/infinitiintouch/fr

FOREWORD

Thank you for purchasing an INFINITI vehicle.

This user's manual is for INFINITI InTouch™ System offered in your INFINITI vehicle.

Operation instructions for the following systems are included in this manual.

- Audio
- Hands-Free Phone
- Apple CarPlay®
- Android Auto
- INFINITI InTouch™ Services
- Navigation
- Voice recognition
- Other systems viewable/operable on the dual display

Please read this manual carefully to ensure safe operation of INFINITI InTouch™ System.

- Because of possible specification changes and optional equipment, some sections of this manual may not apply to your vehicle.

- All information, specifications and illustrations in this manual are those in effect at the time of printing. INFINITI reserves the right to change specifications or design at any time without notice.
- Do not remove this manual from the vehicle when selling this vehicle. The next user of the system may need the manual.
- The latest INFINITI InTouch™ Owner's Manual is available on the following websites.
 - For US: www.infinitiusa.com
 - For Canada: www.infiniti.ca

© 2021 NISSAN MOTOR CO., LTD.

All rights reserved. No part of this Owner's Manual may be reproduced or stored in a retrieval system, or transmitted in any form, or by any means, electronic, mechanical, photocopying, recording or otherwise, without the prior written permission of Nissan Motor Co., Ltd.

Table of Contents

1 Introduction

How to use this manual	1-2
Safety information	1-3
Regulatory information	1-4
Trademarks	1-4
Licenses	1-6

2 Getting started

Control buttons and touch screen display	2-2
Starting system	2-9
Touch panel operation	2-9
Basic operation	2-10
How to operate dual display	2-12
How to view and operate MENU screen	2-17
Functions disabled while driving	2-19
System settings	2-21

3 Audio system

Audio operation precautions	3-2
Names and functions of audio control buttons	3-11
Audio operations	3-12
Audio settings	3-35
CD/USB memory device care and cleaning	3-36

4 Hands-Free Phone

Bluetooth® Hands-Free Phone System	4-2
--	-----

5 Information and vehicle settings

Information menu	5-2
INFINITI InTouch™ Services (if so equipped) ...	5-7
SiriusXM® Travel Link (if so equipped)	5-15
Apple CarPlay®	5-18

Android Auto™	5-22
Siri® Eyes Free	5-26
TomTom Weather information	5-27
Fully customizable digital environment	5-29
Driver Assistance settings	5-32
INFINITI Drive Mode Selector settings	5-34

6 Navigation (if so equipped)

Safety information	6-3
Map operation	6-3
Setting destination	6-14
Route guidance	6-27
Viewing traffic information	6-40
Storing a location/route	6-44
Navigation settings	6-53
General information for navigation system	6-55

7 Voice recognition

Voice recognition 7-2

8 Troubleshooting guide

Customer assistance 8-2

System unit 8-3

Wi-Fi connection (if so
equipped) 8-4

Audio system 8-6

Bluetooth® Hands-Free
Phone System 8-15

INFINITI InTouch™
Services (if so
equipped) 8-19

Apple CarPlay® 8-20

Android Auto 8-22

Siri® Eyes Free 8-24

Navigation (if so
equipped) 8-25

Voice recognition 8-32

1 Introduction

How to use this manual	1-2	Regulatory information	1-4
For safe operation	1-2	Laser product	1-4
Reference symbols	1-2	Bluetooth® devices	1-4
Screen illustrations	1-2	Trademarks	1-4
Terms displayed on screen	1-2	Licenses	1-6
Safety information	1-3	Software Licenses	1-6
		Telematic Control Unit A-IVC (if so equipped)	1-6

1. Introduction

HOW TO USE THIS MANUAL

This manual uses special words, symbols, icons and illustrations organized by function. Please refer to the following items and familiarize yourself with them.

FOR SAFE OPERATION

WARNING

This is used to indicate the presence of a hazard that could cause death or serious personal injury. To avoid or reduce the risk, the procedures must be followed precisely.

CAUTION

This is used to indicate the presence of a hazard that could cause minor or moderate personal injury or damage to your vehicle. To avoid or reduce the risk, the procedures must be followed carefully.

NOTE:

Indicates items that help you understand and maximize the performance of your vehicle. If ignored, they may lead to a malfunction or poor performance.

REFERENCE SYMBOLS

INFO:

This indicates information that is necessary for efficient use of your vehicle or accessories.

 Reference page:

This indicates the title and page that you should refer to.

< >:

Indicates a button on the control panel.

[]:

This indicates a key/item displayed on the screen.

 Voice Command:

This indicates an operation by voice command.

SCREEN ILLUSTRATIONS

- The illustrations in this manual are representatives of various models and may not be identical with the design and specifications of your vehicle.
- Icons and menu items displayed on the screen may be abbreviated or omitted from the screen illustrations when appropriate. The omitted icons and menu items are described as dotted lines as illustrated.

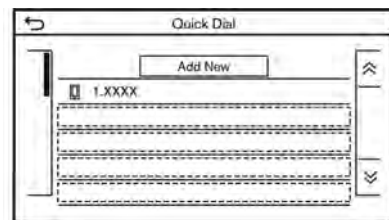

TERMS DISPLAYED ON SCREEN

In this manual, some menu items may be spelled or termed differently from those displayed on your screen depending on models or software versions.

SAFETY INFORMATION

This system is primarily designed to help you support pleasant driving as outlined in this manual. However, you, the driver, must use the system safely and properly. Information and the availability of services may not always be up to date. The system is not a substitute for safe, proper and legal driving. Before using the system, please read the following safety information. Always use the system as outlined in this manual.



WARNING

- To operate the system, first park the vehicle in a safe location and set the parking brake. Operating the system while driving can distract the driver and may result in a serious accident.
- Exercise extreme caution at all times so full attention may be given to vehicle operation. If the system does not respond immediately, please be patient and keep your eyes on the road. Inattentive driving may lead to a crash resulting in serious injuries or death.

- Do not rely on route guidance (if so equipped) alone. Always be sure that all driving maneuvers are legal and safe in order to avoid accidents.
- Do not disassemble or modify this system. If you do, it may result in accidents, fire or electrical shock.
- If you notice any foreign objects in the system hardware, spill liquid on the system or notice smoke or a smell coming from it, stop using the system immediately and it is recommended you contact an INFINITI retailer. Ignoring such conditions may lead to accidents, fire or electrical shock.



CAUTION

- Some jurisdictions may have laws limiting the use of video screens while driving. Use this system only where it is legal to do so.
- Extreme temperature conditions [below -4°F (-20°C) and above 158°F (70°C)] could affect the performance of the system.

- The display screen may break if it is hit with a hard or sharp object. If the display screen breaks, do not touch it. Doing so could result in an injury.



NOTE:

Do not keep the system running with the engine stopped. Doing so may discharge the vehicle battery. When you use the system, always keep the engine running.

1. Introduction

REGULATORY INFORMATION

LASER PRODUCT

Complies with 21 CFR 1040.10 and 1040.11

Complies with 21 CFR Chapter 1, Subchapter J



WARNING

Use of controls or adjustments or performance of procedures other than those specified herein may result in hazardous radiation exposure.

BLUETOOTH® DEVICES

FCC Regulatory information

Changes or modifications not expressly approved by the party responsible for compliance could void the user's authority to operate the equipment.

This device complies with part 15 of the FCC Rules and Industry Canada license-exempt RSS standard(s). Operation is subject to the following two conditions:

(1) This device may not cause harmful interference, and

(2) this device must accept any interference received,

including interference that may cause undesired operation.

Le présent appareil est conforme aux CNR d'Industrie Canada applicables aux appareils radio exempts de licence. L'exploitation est autorisée aux deux conditions suivantes : (1) l'appareil ne doit pas produire de brouillage, et (2) l'utilisateur de l'appareil doit accepter tout brouillage radioélectrique subi, même si le brouillage est susceptible d'en compromettre le fonctionnement.

TRADEMARKS

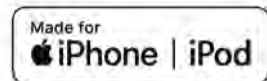

Apple, iPhone®, iPod®, and iPod touch® are trademarks of Apple Inc., registered in the U.S. and other countries. Apple CarPlay® is a trademark of Apple Inc. Use of the Apple CarPlay® logo means that a vehicle user interface meets Apple performance standards. Apple is not responsible for the operation of this vehicle or its compliance with safety and regulatory standards. Please note that the use of this product with iPhone® or iPod® may affect wireless performance.



Bluetooth® is a trademark owned by Blue-

tooth SIG, Inc. and licensed to Robert Bosch GmbH.



HD Radio Technology manufactured under license from iBiquity Digital Corporation. U.S. and Foreign Patents. For patents see <http://dts.com/patents>. HD Radio, Artist Experience, and the HD, HD Radio, and "ARC" logos are registered trademarks or trademarks of iBiquity Digital Corporation in the United States and/or other countries.



INFINITI is offering SiriusXM® services (SiriusXM® Audio, SiriusXM Traffic™, SiriusXM® Travel Link) for free during initial trial period.

SiriusXM® radio, SiriusXM Traffic™ and SiriusXM® Travel Link each require a subscription sold separately, or as a package, by SiriusXM Radio Inc. If you decide to continue service after your trial, the subscription plan you choose will automatically renew there-

after and you will be charged according to your chosen payment method at then-current rates. Fees and taxes apply. Please see our Customer Agreement at www.siriusxm.com for complete terms and how to cancel, which includes calling us at 1-866-635-2349 (for U.S.) or 1-888-539-7474 (for Canada). All fees and programming are subject to change. Not all vehicles or devices are capable of receiving all services offered by SiriusXM. Data displays and individual product availability vary by vehicle hardware. Current information and features may not be available in all locations, or on all receivers. Weather Forecast, Current Conditions may not be available in all locations.



SiriusXM® radio and SiriusXM Traffic™ subscriptions are sold separately or as a package after trial period, and are continuous until you call SiriusXM® at 1-866-635-2349 (for U.S.) or 1-888-539-7474 (for Canada) to cancel. See Customer Agreement for complete terms and more information at www.siriusxm.com. SiriusXM Traffic™ is available in select markets. For

more information, see www.siriusxm.com/infotainment.



SiriusXM® radio and SiriusXM® Travel Link subscriptions are sold separately or as a package after trial period, and are continuous until you call SiriusXM® at 1-866-635-2349 (for U.S.) or 1-888-539-7474 (for Canada) to cancel. See Customer Agreement for complete terms and more information at www.siriusxm.com. SiriusXM® Travel Link is available in select markets. For more information, see www.siriusxm.com/infotainment.



Music recognition technology and related

1. Introduction

data are provided by Gracenote®. Gracenote is the industry standard in music recognition technology and related content delivery. For more information, visit www.gracenote.com.

Music related data from Gracenote, Inc., copyright © 2000 to present Gracenote. Gracenote Software, copyright © 2000 to present Gracenote. One or more patents owned by Gracenote apply to this product and service. See the Gracenote website for a non-exhaustive list of applicable Gracenote patents. Gracenote, the Gracenote logo and logotype are either a registered trademark or a trademark of Gracenote, Inc. in the United States and/or other countries.

App Store

Apple and the Apple logo are trademarks of Apple Inc., registered in the U.S. and other countries. App Store is a service mark of Apple Inc.

Siri®

Siri is a trademark of Apple Inc., registered in the U.S. and other countries.

Google/Google Play/Android/Android Auto

Google, Google Play, Android, Android Auto and other marks are trademarks of Google LLC.

LICENSES

SOFTWARE LICENSES

- Open Source Software Licenses
<http://oss.bosch-cm.com/index.html>
- This product is protected by certain intellectual property rights of Microsoft. Use or distribution of such technology outside of this product is prohibited without a license from Microsoft.

TELEMATIC CONTROL UNIT A-IVC (if so equipped)

<http://opensourceautomotive.com/IC/tZ7T3eE6AiV4>

2 Getting started

Control buttons and touch screen display	2-2	How to operate dual display	2-12
Control buttons and functions	2-2	Upper touch screen display (upper display)	2-12
Dual display	2-3	Lower touch screen display (lower display)	2-16
INFINITI controller (Type A) (if so equipped)	2-4	How to view and operate MENU screen	2-17
INFINITI controller (Type B) (if so equipped)	2-5	Functions disabled while driving	2-19
Steering wheel switches	2-6	System settings	2-21
USB (Universal Serial Bus) connection ports and AUX (auxiliary) input jack (if so equipped)	2-7	Settings menu	2-21
USB connection ports (if so equipped)	2-8	Connections settings	2-27
Starting system	2-9	Volume and Beeps settings	2-31
Start-up screen (if so equipped)	2-9	Clock settings	2-31
Log-in screen	2-9	Screen settings	2-33
Touch panel operation	2-9	Language setting	2-34
Basic operation	2-10	Units settings	2-34
Main screen operations	2-10	Keyboard type settings	2-34
Adjusting and turning ON/OFF settings	2-11	Return all settings to default	2-34
How to input letters and numbers	2-11	Quick setting menu screen	2-34

2. Getting started

CONTROL BUTTONS AND TOUCH SCREEN DISPLAY

CONTROL BUTTONS AND FUNCTIONS

INFINITI InTouch™ controls the heater and air conditioner, audio, RearView/Around View® Monitor, navigation system (if so equipped), Bluetooth® Hands-Free Phone etc., by using the upper and lower display, INFINITI controller, lower display menu buttons and steering wheel switches.

Designs and button layout may vary depending on the specifications and the model.

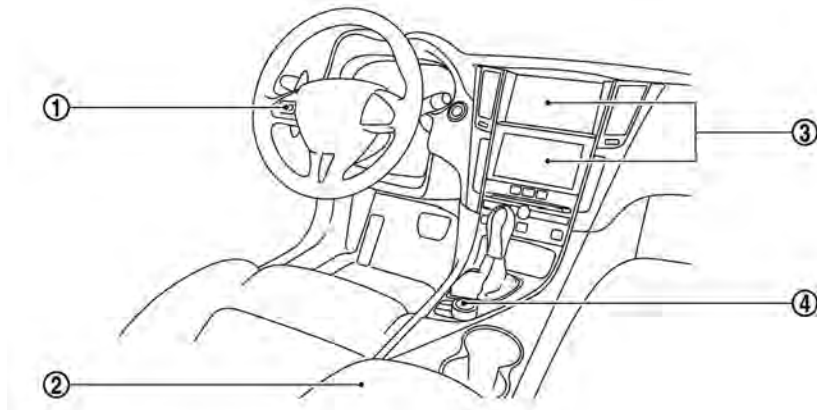

Example

- ① Steering wheel switches
 - ☞ "Steering wheel switches" (page 2-6)
- ② USB (Universal Serial Bus) connection ports and AUX (auxiliary) input jack (if so equipped)

The location of USB connection ports and AUX input jack (if so equipped) may vary depending on the specifications and the model.

 - ☞ "USB (Universal Serial Bus) connection ports and AUX (auxiliary) input jack" (page 2-7)
- ③ Dual display
 - ☞ "USB connection ports" (page 2-8)
 - ☞ "Dual display" (page 2-3)
- ④ INFINITI controller
 - ☞ "INFINITI controller (Type A)" (page 2-4)
 - ☞ "INFINITI controller (Type B)" (page 2-5)

DUAL DISPLAY

The upper touch screen display (upper display) can display various information. The lower touch screen display (lower display) can be used for various operations.

Both displays can be operated with the touch panel operation.

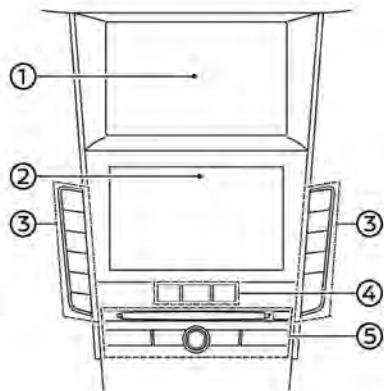

Example

- ① Upper touch screen display (upper display)
Display Information, view monitor system, navigation system (if so equipped).

☞ "Upper touch screen display (upper display)" (page 2-12)

☞ "6. Navigation"

See the vehicle Owner's Manual for details of the view monitor system.

- ② Lower touch screen display (lower display)

Provides touch screen controls for various vehicle features including the navigation system (if so equipped), audio system and the heater and air-conditioner, etc.

☞ "Lower touch screen display (lower display)" (page 2-16)

- ③ Heater and air conditioner buttons

Allow you to control the heater and air conditioner. For details, refer to the vehicle Owner's Manual.

- ④ Lower display menu buttons

Push **<AUDIO>**, **<MENU>** or **<CLIMATE>** to display functions on the lower display.

☞ "Lower display and menu buttons" (page 2-16)

- ⑤ Audio main buttons

Allow you to control the audio.

☞ "Audio main buttons" (page 3-11)

How to handle display

The display is a liquid crystal display and should be handled with care.



WARNING

Never disassemble the display. Some parts utilize extremely high voltage. Touching them may result in serious personal injury.

Characteristics of liquid crystal display:

- If the temperature inside the vehicle is especially low, the display will stay relatively dim or the movement of the images may be slow. These conditions are normal. The display will function normally when the interior of the vehicle has warmed up.
- Some pixels in the display are darker or brighter than others. This condition is an inherent characteristic of liquid crystal displays, and it is not a malfunction.
- A remnant of the previous display image may remain on the screen. This screen burn is inherent in displays, and it is not a malfunction.

2. Getting started

The screen may become distorted by strong magnetic fields.

Maintenance of display:

CAUTION

- To clean the display, stop the vehicle in a safe location.
- Clean the display with the ignition switch in the OFF position. If the display is cleaned while the ignition switch is in the ON position, unintentional operation may occur.
- To clean the display, never use a rough cloth, alcohol, benzene, thinner and any kind of solvent or paper towel with a chemical cleaning agent. They will scratch or deteriorate the panel.
- Do not splash any liquid such as water or car fragrance on the display. Contact with liquid will cause the system to malfunction.

- When cleaning the display, use the dedicated cleaning cloth.
- Before cleaning, wipe away any sand or dust from the surface of the display and

shake out the exclusive cloth in order to prevent damaging the display.

- If the display is heavily soiled, moisten the dedicated cleaning cloth and then clean the display. If the exclusive cloth is moistened, be sure to dry it out sufficiently before storing it. Color may be transferred to objects that it comes in contact with.
- The dedicated cleaning cloth retains its cleaning properties even if it is washed repeatedly.
- When washing the exclusive cloth, be sure to rinse it thoroughly so that no detergent remains.
- When ironing the exclusive cloth, iron using a low temperature setting 176 to 248 °F (80 to 120°C).

INFINITI CONTROLLER (Type A) (if so equipped)

The INFINITI controller operates the upper display.

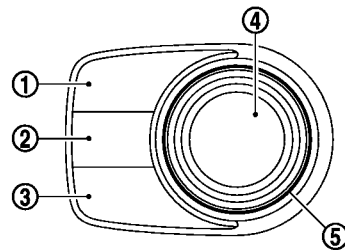

① <MAP/VOICE> (models with navigation system)

Push to display the vehicle's current location on the map.

Push again to display the display view bar.

 "Changing display view"
(page 2-14)

Push and hold to hear the current guidance for a programmed route.

<DISP> (models without navigation system)

Push to display the displayed feature screen.

 "Changing display view"
(page 2-14)

② < ⏪ >

Push to go back to the previous screen.

③ < CAMERA  * / > (models with Around View® Monitor system)

Push to view the Around View® Monitor screen.

Refer to the vehicle Owner's Manual for details.

Push and hold to control the brightness.

 "Screen settings" (page 2-33)

< * / > (models without Around View® Monitor system)

Push for brightness control.

 "Screen settings" (page 2-33)

④ < ≡ / OK >

Push to enter the selected item.

Models with navigation system:

If this button is pushed while a map is displayed, the shortcut menu is shown on the upper display.

 "Shortcut menu" (page 2-12)

Models without navigation system:

When this button is pushed when no item is selected, the shortcut menu is shown on the upper display.

 "Shortcut menu" (page 2-12)

⑤ Center dial/Slide switch

Slide or turn to select an item on the upper display or to adjust a setting (volume, brightness, etc.).

Models with navigation system:

While the map screen is displayed, adjust the map scale by turning the dial.

 "Changing scale of map" (page 6-7)

While the map screen is displayed, scroll the map screen by sliding the switch.

 "Moving map" (page 6-6)

 **INFO:**

While Apple CarPlay® or Android Auto screen is displayed on the upper display, < ≡ / OK >, < ⏪ > and Center dial/Slide switch can operate Apple CarPlay® or Android Auto screen.

 "Apple CarPlay®" (page 5-18)

 "Android Auto™" (page 5-22)

INFINITI CONTROLLER (Type B)
(if so equipped)

The INFINITI controller operates the upper display.

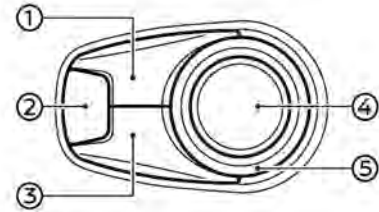

① < MAP / VOICE > (models with navigation system)

Push to display the vehicle's current location on the map.

Push again to display the display view bar.

 "Changing display view" (page 2-14)

Push and hold to hear the current guidance for a programmed route.

< DISP > (models without navigation system)

Push to display the displayed feature screen.

 "Changing display view" (page 2-14)

2. Getting started

- ② <CAMERA  * / > (models with Around View® Monitor system)

Push to view the Around View® Monitor screen.

Refer to the vehicle Owner's Manual for details.

Push and hold to control the brightness.

 "Screen settings" (page 2-33)

<* / > (models without Around View® Monitor system)

Push for brightness control. Push and hold to turn the display on/off (for the upper and lower displays).

 "Screen settings" (page 2-33)

- ③ < >

Push to go back to the previous screen.

- ④ < ≡ /OK >

Push to enter the selected item.

Models with navigation system:

If this button is pushed while a map is displayed, the shortcut menu is shown on the upper display.

 "Shortcut menu" (page 2-12)

Models without navigation system:

If this button is pushed when no item is selected, the shortcut menu is shown on

the upper display.

 "Shortcut menu" (page 2-12)

- ⑤ Center dial/Slide switch

Slide or turn to select an item on the upper display or to adjust a setting (volume, brightness, etc.).

Models with navigation system:

While the map screen is displayed, adjust the map scale by turning the dial.

 "Changing scale of map" (page 6-7)

While the map screen is displayed, scroll the map screen by sliding the switch.

 "Moving map" (page 6-6)

INFO:

While Apple CarPlay® or Android Auto screen is displayed on the upper display, < ≡ /OK >, < > and Center dial/Slide switch can operate Apple CarPlay® or Android Auto screen.

 "Apple CarPlay®" (page 5-18)

 "Android Auto™" (page 5-22)

STEERING WHEEL SWITCHES

The steering wheel switches mainly control the upper display (volume adjustment, menu selection, voice recognition, Hands-Free Phone).

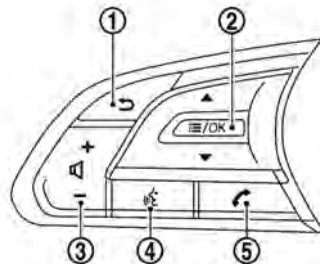

- ① < > (BACK)

Push this switch during a setting operation to return to the previous screen.

- ② < ≡ /OK >

Tilt to select an item on the screen. Push to enter the selected item.

Audio operations are possible by tilting the switch.

 "Steering wheel mounted audio control" (page 3-12)

Models with navigation system:

When this switch is pushed while a map is displayed, the shortcut menu is shown on the upper display.

☞ "Shortcut menu" (page 2-12)

Models without navigation system:

When this switch is pushed when no item is selected, the shortcut menu is shown on the upper display.

☞ "Shortcut menu" (page 2-12)

③ <- 🔊 + > (Volume control)

Push to adjust the volume.

④ < 🗨️ > (TALK)

Push to use the Voice Recognition System.

☞ "Giving voice commands"
(page 7-2)

Pushing and holding this switch will allow various operations depending on the conditions.

- While using the Voice Recognition System, exit the voice recognition session.

☞ "Giving voice commands"
(page 7-2)

- When Apple CarPlay® or Android Auto is active, start a Siri® or Google Assistant session.

☞ "Siri® operation" (page 5-20)

☞ "Google Assistant™ operation"
(page 5-24)

- When your iPhone® is connected to in-vehicle system via Bluetooth® with Apple CarPlay® not used, Siri® Eyes Free is activated.

☞ "Siri® Eyes Free" (page 5-26)

- When the Voice Recognition System, Apple CarPlay® and Android Auto is not used with no Bluetooth® device connected, the Bluetooth® connection screen is displayed.

☞ "Setting devices" (page 2-27)

⑤ < 📞 > (PHONE)

Push to display the Hands-Free Phone operation screen.

When you receive a phone call, push this switch to answer the call.

☞ "4. Hands-Free Phone"

Pushing and holding this switch will start a voice recognition session for making a phone call.

USB (Universal Serial Bus) CONNECTION PORTS AND AUX (auxiliary) INPUT JACK (if so equipped)

The vehicle is equipped with USB connection ports and an AUX input jack. When connected, the in-vehicle audio system can play audio contents from the compatible device.

The USB connection ports and the AUX input jack are located in the center console box.

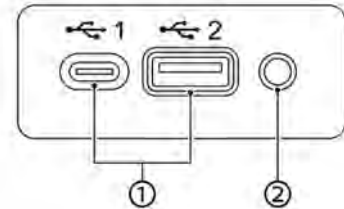

① USB connection ports:

Connect a compatible device to play media such as an iPod® or a USB memory device.

Connect an iPhone® or an Android phone to use Apple CarPlay® or Android Auto.

2. Getting started

② AUX (Auxiliary) input jack:

Connect an audio player that accepts a 1/8 in (3.5 mm) TRS connector (such as an MP3 player etc.) to play music.

! NOTE:

- Refer to your AUX and USB device manufacturer's owner information regarding the proper use and care of the device.
- The USB connection port (for USB Type-A) can be used for charging the connected USB device (maximum output up to 5 volts, 2.4 A). For USB connection port (for USB Type-C), maximum output is up to 5 volts, 3.0 A. The USB device will be charged continuously while the ignition switch is in the ACC or ON position. Some USB devices cannot be charged according to their specifications.
- Cables made by Apple Inc. should be used to connect electronic devices marketed by Apple Inc.

USB CONNECTION PORTS (if so equipped)

The vehicle is equipped with USB connection ports. When connected, the in-vehicle audio system can play audio contents from the compatible device.

USB connection ports are located on the center console or the lower part of the instrument panel.

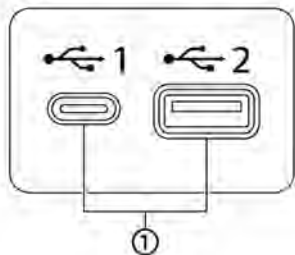

① USB connection ports:

Connect a compatible device to play media such as an iPod® or a USB memory device.

Connect an iPhone® or an Android phone to use Apple CarPlay® or Android Auto.

! NOTE:

- Refer to your USB device manufacturer's owner information regarding the proper use and care of the device.
- The USB connection port (for USB Type-A) can be used for charging the connected USB device (maximum output up to 5 volts, 2.4 A). For USB connection port (for USB Type-C), maximum output is up to 5 volts, 3.0 A. The USB device will be charged continuously while the ignition switch is in the ACC or ON position. Some USB devices cannot be charged according to their specifications.
- Cables made by Apple Inc. should be used to connect electronic devices marketed by Apple Inc.

STARTING SYSTEM

The system starts when the ignition switch is placed in the ACC or ON position.

START-UP SCREEN (if so equipped)

The start-up screen is displayed when the ignition switch is placed in the ACC or ON position.

After an animated start-up screen is displayed, a message screen will be displayed. Touch [OK] after reading and agreeing to the message displayed on the screen. If you do not agree to the message, some of the functions on the system will be disabled.

NOTE:

Do not keep the system running with the engine stopped. Doing so may discharge the vehicle battery. When you use the system, always keep the engine running.

INFO:

Once you select [Decline] on the start-up screen, the [OK]/[Decline] screen will not be displayed for 30 days.

LOG-IN SCREEN

Three unique users can be recognized by the vehicle, with personal settings linked to the Intelligent Key assigned to each user. When [Welcome Message] is ON, a welcome message screen is displayed with the detected user's name each time the system starts.

☞ "Setting INFINITI InTuition feature" (page 5-31)

When an Intelligent Key is used for the first time, the vehicle will prompt the user to create a new registration with a guidance on the lower display.

☞ "User registration" (page 5-29)

1. The system starts when the ignition switch is placed in the ON position. A welcome message screen is displayed.
2. Check the message that is displayed on the screen. If the name shown in the welcome message is incorrect, touch to select the preferred user. Touching [OK] or [INFINITI InTuition] on the MENU screen can also change the user.

☞ "How to view and operate MENU screen" (page 2-17)

TOUCH PANEL OPERATION

Basic touch panel operation methods are explained here.

• Touch

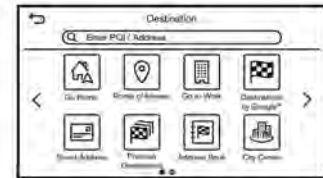
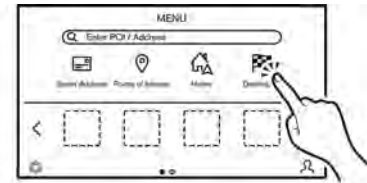

Example

Select and execute the selected key on the screen.

2. Getting started

- **Swipe**

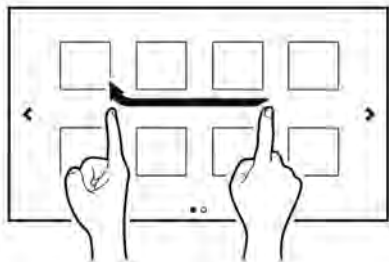

Menu screen pages will skip to the next page.

- **Drag**

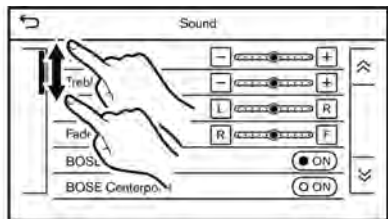

Drag up or down to scroll. You can scroll up and down a list screen.

Models with navigation system:

Various further operations are possible for a map screen.

 "Operating with touch panel operation" (page 6-6).

BASIC OPERATION

MAIN SCREEN OPERATIONS

The following operations are generally available on the various screen.

- **Displaying previous screen**

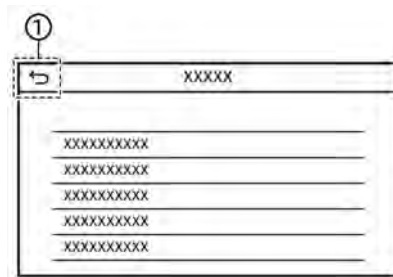

① Touch [] to return to the screen displayed previously.

- **Vertical scrolling**

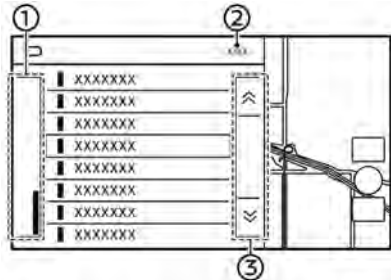

Example

- ① Drag the scroll bar up or down to scroll the message or list up or down.
- ② Indicates the number of the list items.
- ③ Touch [\blacktriangle] or [\blacktriangledown] to skip to the previous or next page.

 **INFO:**

Depending on the screens, swiping on the touch screen can scroll pages vertically or horizontally.

- **Scrolling list by selecting alphabet**

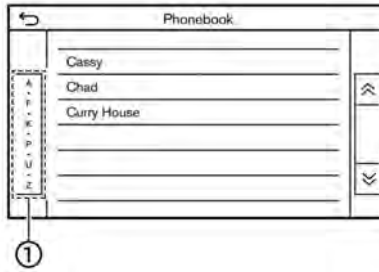

- ① Touch a preferred location within the alphabetical list. The detailed alphabetical list will be shown. Touch to scroll the list items to the section that begins with the letter selected.

ADJUSTING AND TURNING ON/OFF SETTINGS

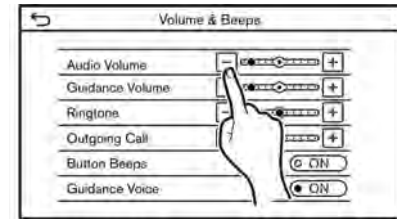

Example

Touch adjustment keys, such as [-]/[+], etc., to adjust each item. Each time a key is touched, the indicator moves along the bar.

For items with [ON] indicator, touch the menu item to turn on/off the setting. The indicator light will turn on when the setting is turned on.

HOW TO INPUT LETTERS AND NUMBERS

Basic operations to enter letters and numbers are explained here.

Character and number input screens vary depending on the conditions.

2. Getting started

Character input screen

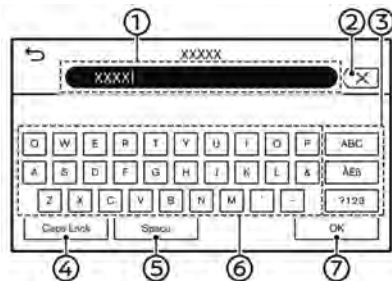

- ① Entered characters are displayed.
Touch the preferred position to move the character input position.
- ② Touch to delete the last character entered.
Touch and hold to delete all the characters entered.
- ③ Touch to change the type of keyboard.
- ④ Touch to switch between the uppercase and lowercase character input screen.
- ⑤ Touch to enter a space.
- ⑥ Touch to enter a character.
- ⑦ Touch to confirm the entry.

Number input screen

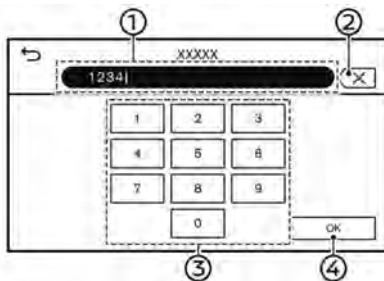

- ① Entered numbers are displayed.
Touch the preferred position to move the character input position.
- ② Touch to delete the last number entered.
Touch and hold to delete all the numbers entered.
- ③ Touch to enter a number.
- ④ Touch to confirm the entry.

HOW TO OPERATE DUAL DISPLAY

UPPER TOUCH SCREEN DISPLAY (upper display)

The upper touch screen display (upper display) mainly displays the information, the view monitor system or the navigation map (if so equipped) screen.

For operating the upper display, touch the display directly, push the steering wheel switch or use the INFINITI controller.

Shortcut menu

The shortcut menu can be displayed on the upper display.

Models with navigation system:

The shortcut menu may differ according to the map scrolling or the map displaying the current position.

2. Getting started

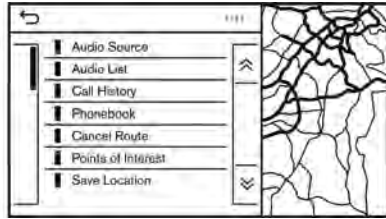

Example









While the current vehicle location is displayed on the map screen, push < ≡ /OK> on the INFINITI controller or the steering wheel to display the shortcut menu on the upper display.

INFO:

Touching  on the map screen will also display the shortcut menu.

Available option menus may vary depending on models, specifications and software versions.

The following options are available.



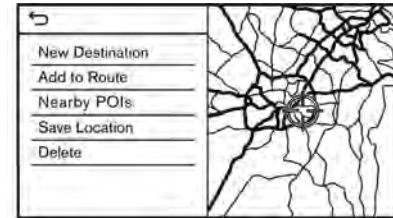

- [Steering Assist]
Refer to the vehicle Owner's Manual.
- [TURN ALC ON]/[TURN ALC OFF]
Refer to the vehicle Owner's Manual.
- [Audio Source]
 "Selecting audio source"
(page 3-13)
- [Audio List]
 "Audio main operation" (page 3-12)
- [Call History]
 "Making a call" (page 4-5)
- [Phonebook]
 "Making a call" (page 4-5)
- [Cancel Route]
 "Canceling Route" (page 6-33)
- [Points of Interest]
 "Finding points of interest"
(page 6-18)
- [Save Location]
 "Storing location by moving map"
(page 6-45)
- [Split Map Views]
 "Changing display view"
(page 2-14)
- [Customize This Menu]
Edit items to be displayed in the shortcut menu.
 - [Change Menu Order]
Change the order in which shortcut menu items are shown. Touch and

drag the item to the position in the list where you wish to insert it.

- [Edit Menu Items]
Select items to be displayed in the shortcut menu.



While scrolling the map screen, push < ≡ /OK> on the INFINITI controller or the steering wheel to display the following options.





- [New Destination]
 "Setting point on map" (page 6-25)
- [Add to Route]
 "Setting destination or waypoint"
(page 6-37)
- [Nearby POIs]
 "Finding points of interest"
(page 6-18)
- [Save Location]
 "Storing location by moving map"

2. Getting started

(page 6-45)

- [Delete]
☞ "Deleting individual item on map"
(page 6-52)

INFO:

- Touch  to display the Google Map Satellite View. Touching  or  on the satellite view screen can change the map scale.
- Touch  to display Google Street View. The view can be shifted to left and right by touching [

Models without navigation system:

When <  /OK> on the INFINITI controller or steering wheel is pushed when no item is selected, the shortcut menu is shown on the upper display.

INFO:

Touching  on the upper display will also display the shortcut menu. Available option menus may vary depending on models, specifications and software versions. The following options are available.

- [Audio Source]
☞ "Selecting audio source"
(page 3-13)
- [Audio List]
☞ "Audio main operation" (page 3-12)
- [Call History]
☞ "Making a call" (page 4-5)
- [Phonebook]
☞ "Making a call" (page 4-5)
- [Displayed Feature]
☞ "Changing display view"
(page 2-14)
- [Customize This Menu]
Edit items to be displayed in the shortcut menu.
 - [Change Menu Order]
Change the order in which shortcut menu items are shown. Touch and drag the item to the position in the list where you wish to insert it.
 - [Edit Menu Items]
Select items to be displayed in the shortcut menu.

Changing display view

Various information screens can be shown on the upper display by selecting from the

display view bar (for models with navigation system) or displayed feature screen (for models without navigation system).

For models with navigation system, set display will be shown in addition to the navigation map.

Push <MAP/VOICE> (models with navigation system) on the INFINITI controller while the current vehicle location is displayed on the map to show the display view bar or push <DISP> (models without navigation system) on the INFINITI controller to show the displayed feature screen.

Select an item in the display view bar (for models with navigation system)/displayed feature screen (for models without navigation system). The current view will change accordingly.

Available display views may vary depending on models, specifications and software versions.

2. Getting started

Available View	Action
[Full Map]	Displays full map screen.
[Split Screen: Dual Map]	The map can be displayed on a split screen. Each screen can be adjusted independently.
[Intersection]	The enlarged view of the next intersection is always displayed on the left side of the split screen. When no route is set, the intersection screen is not displayed and the map is displayed on the full screen.
[Turn List]	Displays the turn list on the left side of the split screen. When approaching a guide point, the turn list automatically switches to an enlarged view of the intersection. When no route is set, the turn list screen is not displayed and the map is displayed in the full screen.
[Where Am I?]	Displays the information about the current vehicle location.
[Split Screen: Turn by turn]	Displays a turn point information when driving according to route guidance.
[Fuel Economy]	Fuel economy information can be checked while driving.
[Audio]	Displays current audio status information.
[TomTom Current Conditions]	TomTom current weather information is displayed.
[TomTom 5-Day Weather Forecast]	TomTom 5-day weather information is displayed.
[TomTom Hourly Weather Forecast]	TomTom hourly weather information is displayed.
[SXM Current Conditions]	SXM current weather information is displayed.
[SXM 5-Day Weather Forecast]	SXM 5-day weather information is displayed.
[SXM Hourly Weather Forecast]	SXM hourly weather information is displayed.
[SXM Sports Scores]	SXM sports information is displayed.
[Analog Clock]	The analog clock and date can always be displayed.
[Digital Clock]	The digital clock and date can always be displayed.

2. Getting started

Customizing the display view bar (models with navigation system)

The menu icons on the display view bar can be customized to your preference.

1. Push **<MENU>** and touch [Settings].
2. Touch [Navigation] and touch [Map settings].
3. Touch [Split Screen View] and touch [Change Order].
4. Touch and drag the item to the position in the list where you wish to insert it.

LOWER TOUCH SCREEN DISPLAY (lower display)

Lower display and menu buttons

The lower display provides touch screen controls for various vehicle features including the audio system, heater and air conditioner system and navigation system (if so equipped).

This manual mainly explains the operation on the lower display.

<AUDIO>, **<MENU>** and **<CLIMATE>** are located on the bottom of the lower display.

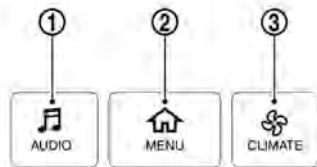

Push **<AUDIO>**, **<MENU>** or **<CLIMATE>** to display functions on the lower display.

Push **<AUDIO>** ①:



Displays the audio screen.

When **<AUDIO>** is pushed while the audio screen is displayed, the source menu screen will be displayed.

☞ "3. Audio system"

Push **<MENU>** ②:



Example

Almost all functions, such as navigation settings (if so equipped), phone connection, information screen display and other set-

tings can be accessed from this menu.

☞ "How to view and operate MENU screen" (page 2-17)

Push <CLIMATE> ③:

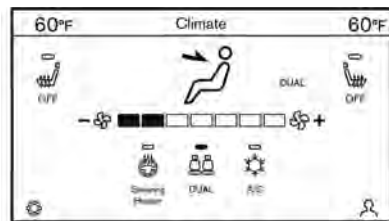

Example

The current climate control information is displayed on the lower display. Directly touch the key to operate the functions of the air conditioner.

For details, refer to the vehicle Owner's Manual.

HOW TO VIEW AND OPERATE MENU SCREEN

Push <MENU> to display the MENU screen on the lower display.

The MENU screen can display preferred shortcuts and widgets.

Available option menus may vary depending on models, specifications and software versions.

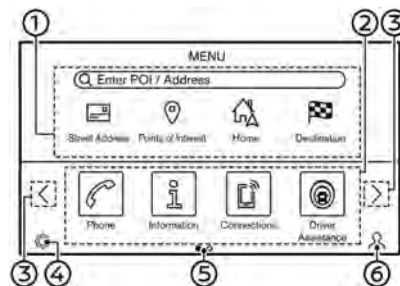

Example

- ① Navigation menu (models with navigation system):

Navigation related menu is displayed. Menu items differ depending on the destination settings.

The following menus are displayed.

Without setting a destination:

[Enter POI/Address]

☞ "Free Text Search" (page 6-17)

[Street Address]/[Destinations by Google]

☞ "Finding address" (page 6-18)

☞ "Setting destinations by Google™" (page 6-21)

[Points of Interest]

☞ "Finding points of interest" (page 6-18)

[Home]

☞ "Setting home or work location as destination" (page 6-17)

[Destination]/[More Choices...]

☞ "Displaying destination setting menu" (page 6-14)

With setting a destination:

[Enter POI/Address]

☞ "Free Text Search" (page 6-17)

[Cancel Route]

☞ "Canceling Route" (page 6-33)

[Turn List]

☞ "Displaying Turn List" (page 6-33)

[Route Options]

☞ "Route options menu" (page 6-30)

[Destination]/[More Choices...]

2. Getting started

 "Displaying destination setting menu" (page 6-14)

② Home menu:

Shortcuts for various functions are displayed. Available items may vary depending on models, specifications and software versions.

Available items:

[Phone]

 "4. Hands-Free Phone"

[Information]

 "5. Information and vehicle settings"

[Connections]

 "Connections settings" (page 2-27)

[Driver Assistance]

 "Driver Assistance settings" (page 5-32)

[InTouch Services]

 "INFINITI InTouch™ Services" (page 5-7)

[Settings]

 "Settings menu" (page 2-21)

[INFINITI Drive Mode Selector]

 "INFINITI Drive Mode Selector settings" (page 5-34)

[INFINITI InTuition]

 "Fully customizable digital environment" (page 5-29)

[Quick Guide]

Displays the operation guide on the lower display.



INFO:

[Phone] will be replaced by [Apple CarPlay] when Apple CarPlay® is active, and it will be replaced by [Android Auto] when Android Auto is active.

③ [] / []:

Touch [] / [] to scroll to the previous/next page.

④ []:

Touch [] to access the quick setting menu screen.

 "Quick setting menu screen" (page 2-34)

⑤ Indicates the position of the currently displayed page.

⑥ []:

Touch [] to display User Profiles screen.

 "Fully customizable digital environ-

ment" (page 5-29)

FUNCTIONS DISABLED WHILE DRIVING

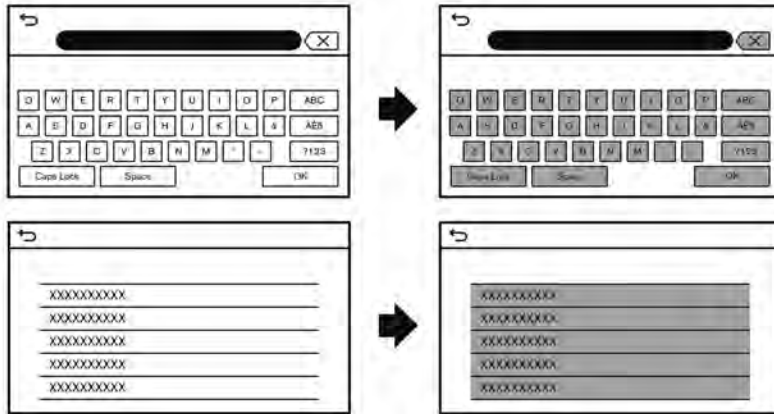

Example

To ensure safe driving, some functions cannot be operated or have limited operation while the vehicle is in motion.

The on-screen text and keys for these restricted functions will be “grayed-out” or muted and cannot be selected while driving. In some cases, a screen message will appear indicating a restricted function.

Restricted functions while driving include:

- Character (letter and number) input screen
- Scrolling and viewing of certain list screens
- Displaying detailed information and selecting items on some information screens
- Adding/editing home location, address book entries and current route
- Connecting Bluetooth® devices for the first time
- Placing a call by dialing a number or selecting a phonebook entry
- Adjusting settings for phone, INFINITI InTouch™ Services (if so equipped), Bluetooth® functions, and other various functions

2. Getting started

These functions will become available again when the vehicle is not in motion.

Some of the destination setting functions that become unavailable while driving can be operated by the Voice Recognition System.

SYSTEM SETTINGS









The system settings can be changed for personal convenience.

SETTINGS MENU



Push **<MENU>** and touch [Settings] to display the settings menu screen on the lower display.

Available setting items may vary depending on models, specifications and software versions.

Available setting items

Setting item	Result
[Connections]	Displays the connected devices, Wi-Fi (if so equipped) and USB settings screen.  "Connections settings" (page 2-27)
[Phone]	Displays the phone and text message settings screen.  "Phone and text message settings" (page 4-11)
[Navigation]	Displays the navigation settings screen.  "Navigation settings" (page 6-53)
[Sound]	Displays the audio settings screen.  "Audio settings" (page 3-35)
[Screen]	Displays the display settings screen.  "Display Settings" (page 2-33)
[Volume & Beeps]	Displays the volume adjustment screen.  "Volume and Beeps settings" (page 2-31)
[Clock]	Displays the clock adjustment screen.  "Clock settings" (page 2-31)
[Customize Audio Sources]	Displays the editing screen for the audio source bar.  "Selecting from source bar" (page 3-13)

2. Getting started

Setting item	Result	
[System Voice]	Displays the system voice settings screen.  "System Voice settings" (page 7-7)	
[Camera]	Displays the camera settings screen. See the vehicle Owner's Manual for details of the view monitor system.	
[Parking Sonar]	Displays the sonar settings screen. See the vehicle Owner's Manual for details of the sonar system.	
[InTouch Services]	Displays the INFINITI InTouch™ Services settings screen.  "INFINITI InTouch™ Services settings" (page 5-14)	
[Comfort & Convenience] (The availability of menu items under [Comfort & Convenience] depends on the models, specifications and software versions.)	[Ambient Light]	Sets the Ambient Light settings.
	[Lamp ON when Door Unlocks]	When this item is set to on, the interior lights illuminate when any door is unlocked.
	[Light Sensitivity]	Sets the Auto Light sensitivity.
	[Light Off Delay]	Sets the Auto Light Delay Timer.
	[Remote Engine Start]	Sets the Remote Engine Start.
	[Speed Sensing Wiper Interval]	Sets the wiper interval is adjusted automatically according to the vehicle speed.
	[Auto unlock]	Sets the Auto unlock (I-key) conditions.
	[Welcome Light]	Sets the Welcome Light.
	[Rain Sensor]	Sets the rain-sensing auto wiper system.
	[Answer Back]	Sets the Answer back timing.
[Battery Saver Mode]	Sets Battery Saver Mode.	
[Lock/Unlock by Door Handle]	Sets Lock/Unlock by Door Handle.	

2. Getting started

Setting item	Result
[Touch Sensitive Door Sensor]	When this item is turned ON, you can unlock vehicle doors by touching the inside of the door handle. When it is OFF, you can unlock vehicle doors by pushing the request switch. Refer to the vehicle Owner's Manual for details.
[Lane Change (3 Flashes)]	Sets Lane change 3 flash.
[Reverse Link Wiper]	Sets the Reverse Link Wiper.
[Drip Wipe]	Sets Drip wipe.
[Answer Back Exterior Light]	Sets welcome light and farewell light function.
[Selective Door Unlock]	When this item is turned ON, you can use this function to unlock an assigned door. When this item is turned OFF, all doors will unlock.
[Lift Steering upon Exit]	Sets Lift Steering upon Exit.
[Slide Driver Seat Back on Exit]	Sets Driver Seat Back on Exit.
[Return All Settings to Default]	All vehicle setting values are returned to the default settings.
[Drive Mode Enhancement]	[ECO Pedal]
	Sets the ECO pedal to [OFF], [Soft], or [Standard]. Refer to the vehicle Owner's Manual for details.









2. Getting started

Setting item		Result	
[Meter]	[Main Menu Selection]	[HOME]	Selects the preferred item to be displayed on the vehicle information display. Refer to the vehicle Owner's Manual for details of each item.
		[Audio]	
		[Navigation]	
		[Range]	
		[Instant Speed]	
		[Average Speed]	
		[Trip Distance & Time]	
		[Fuel Economy]	
		[Cruise]	
		[Driving Aids]	
		[Tire Pressure]	
		[Variable Compression Turbo]	
		[Chassis Control]	
		[Traffic sign]	
[Blank]			
[Eco mode settings]	[Display Mode]	Switch the display modes between [Pedal Guide] and [Instant Fuel Economy].	

2. Getting started

Setting item			Result
	[Maintenance]	[Oil and Filter]	The following settings are available for each maintenance item. [Distance]: Sets the interval (mileage) of the maintenance schedule. To determine the recommended maintenance interval, refer to the separate maintenance booklet. [Reminder]: To display the reminder automatically when the desired distance is reached, select the [Reminder] key. [Reset Distance]: Reset the driving distance to the new maintenance schedule.
		[Tire]	
		[User]	
	[Alarms]	[Low Temperature]	Sets the low temperature alert to on/off.
		[Timer Alert]	Adjust the alert timer setting.
		[Navigation]	Sets turn by turn to on/off.
	[Display Effect]	Sets Illumination effect to on/off.	
	[TPMS setting]	Sets the Tire Pressure Monitoring System (TPMS) settings such as tire pressure unit change, etc.	
	[Cruise]	[Cruise Screen Transition]	To display the Intelligent Cruise Control (ICC) system display automatically when the ICC system is activated. For detail of the ICC system, refer to the vehicle Owner's Manual.
	[Language]	Sets the preferred language for the meter.	
[Factory Reset]	Resets the meter to the default values.		
[Others]	[Climate]	Sets the heater and air conditioner to your preferred settings. Refer to the vehicle Owner's manual for details.	
	[Language]	Displays the language settings screen.  "Language setting" (page 2-34)	

2. Getting started

Setting item		Result
	[Units]	Displays the units settings screen.  "Units settings" (page 2-34)
	[Keyboard Type]	Displays the keyboard type settings screen.  "Keyboard type settings" (page 2-34)
	[Return All Settings to Default]	Resets all settings to default.  "Return all settings to default" (page 2-34)
[Head Up Display]		The position and the brightness of the Head Up Display can be adjusted. Touching [Display items] can select the items to be displayed on the Head Up Display. Touching [Reset] can reset the settings. Refer to the vehicle Owner's Manual for details.
[Apps]	[Connections]	Displays the Connections settings screen.  "Connections settings" (page 2-27)
	[Vehicle's Help for Apple CarPlay]	Displays helpful tips for Apple CarPlay® operation.  "Apple CarPlay®" (page 5-18)
	[Vehicle's Help for Android Auto]	Displays helpful tips for Android Auto operation.  "Android Auto™" (page 5-22)
[System Update]	[Version Information]	Displays the information of the Software Version, etc.
	[Software Update]	The system software can be updated.  "Updating system software" (page 5-5)
	[Map Update]	The map data can be updated.  "How to update map data" (page 6-61)

CONNECTIONS SETTINGS

Changing the settings and viewing information of connected devices, Wi-Fi (if so equipped) and USB are available on the Connections settings screen.

Setting devices

Settings of the connected devices, such as smartphones used for Hands-Free Phone, Apple CarPlay®, Android Auto, etc., can be changed.

The information of the devices can also be confirmed.

☞ "Apple CarPlay®" (page 5-18)

☞ "Android Auto™" (page 5-22)

☞ "Bluetooth® Hands-Free Phone System" (page 4-2)

☞ "Bluetooth® audio operation" (page 3-32)

Connecting cellular phone/audio device:

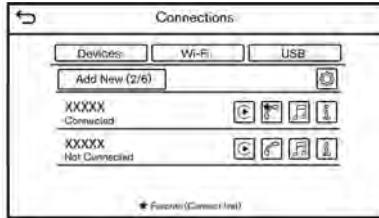

Example

To use the Bluetooth® device with the in-vehicle system for the first time, the device connection operation is required.

1. Push **<MENU>** and touch [Connections].
2. Touch [Devices] and touch [Add New]. A message is displayed.



INFO:

If no Bluetooth® device is connected and Apple CarPlay® or Android Auto is not active, the same screen can be displayed by pushing and holding **< Ⓜ >** on the steering wheel.

3. Operate as guided by the system. (Operations may differ depending on the device.)



NOTE:

Some cellular phones or other devices may cause interference or a buzzing noise to come from the audio system speakers. Storing the device in a different location may reduce or eliminate the noise.



INFO:

- The paired device will be added to the list on the Devices screen.
- Touching the name of the other device on the list will switch the connected device.
- Touching [📱] will allow the device to activate/deactivate Apple CarPlay®. This icon is displayed if the device is compatible with Apple CarPlay®.
- Touching [📱] will allow the device to activate/deactivate Android Auto. This icon is displayed if the device is compatible with Android Auto.
- Touching [📱] will allow the device to be connected via Bluetooth® and be used on the Hands-Free Phone System.
- You can set a favorite hands-free phone. The [📱] by the phone device name selected as a favorite will be marked

2. Getting started

with "★".

"Bluetooth® settings" (page 2-28)

- Touching will allow the device to be connected via Bluetooth® and be used for Bluetooth® Audio.
- You can set a favorite Bluetooth® audio device. The by the audio device name selected as a favorite will be marked with "★".
 "Bluetooth® settings" (page 2-28)
- Touching will display the information of the device.
 "Device information" (page 2-29)
- Up to 6 Bluetooth® devices can be connected. If 6 devices are already connected, one of the devices must be deleted before connecting another device.
- The pairing procedure varies according to each device. See the device Owner's Manual for the details.
- Visit www.infiniti.com/bluetooth/ for a recommended Bluetooth® device.

Bluetooth® settings:

The Bluetooth® settings can be changed according to your preference.

1. Push **<MENU>** and touch [Connections].
2. Touch [Devices].
3. Touch .

Available setting items

Setting item	Action
[Bluetooth]	Turns the Bluetooth® connection on/off.
[Allow 2 Phones Simultaneously]	When turned on, up to 2 Bluetooth® devices can be connected to the in-vehicle system simultaneously.
[Favorite Phone]	A Bluetooth® device can be registered as a favorite hands-free phone. If the hands-free phone device is within the range with Bluetooth® turned on, the device registered as favorite will automatically be connected to the in-vehicle system with priority upon the system activation. Favorite phone is marked with "★" in the device list.

[Favorite Audio]	A Bluetooth® device can be registered as a favorite audio device. If the Bluetooth® audio device is within the range with Bluetooth® turned on, the device registered as favorite will automatically be connected to the in-vehicle system with priority upon the system activation. Favorite audio device is marked with "★" in the device list.
[Device Name]	The device name can be changed.
[PIN]	The PIN code can be changed.



INFO:

With [Device Name], the device name that appears on the screen can be changed and be renamed from the name set as default to the preferred name (such as "Steve's Car" for example).

Device information:

You can display the information of the devices connected to the vehicle.

1. Push **<MENU>** and touch [Connections].
2. Touch [Devices].
3. Touching [] by the device name will display the information of the device.

Available setting items may vary depending on models, specifications and software versions.

Available setting items

Setting item	Action
[Delete]	Paired devices can be deleted from the list.
[Device Information]	Displays the information of connected Bluetooth® device.
[Smartphone Projection]	Displays the smartphone setting screen. [] "Apple CarPlay® settings" (page 5-21) [] "Android Auto settings" (page 5-25)

Deleting device information:

Paired devices can be deleted from the list.

1. Push **<MENU>** and touch [Connections].
2. Touch [Devices].
3. Touch [] by the device name you wish to delete.
4. Touch [Delete]. Touch [Yes] when a message appears.

Wi-Fi Setting (if so equipped)

A Wi-Fi connection can be made by using an available Wi-Fi network near the vehicle or using the Wi-Fi hotspot function (if so equipped), etc. Wi-Fi connectivity is useful for updating map data (if so equipped) and system software, or using online services, such as Online Search (if so equipped) or Premium Traffic (if so equipped).

- [] "Updating system software" (page 5-5)
- [] "How to update map data" (page 6-61)
- [] "Free Text Search" (page 6-17)
- [] "Premium Traffic information" (page 6-41)

Connecting to a Wi-Fi network:

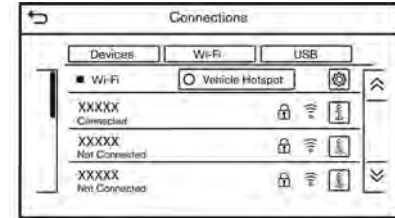

Example

To use the Wi-Fi connection for the first time, the following connecting procedures are required.

1. Push **<MENU>** and touch [Connections].
2. Touch [Wi-Fi].
3. Touch the name of the device you wish to connect.

[]	Indicates that a password is set.
[]	Indicates the strength of the signal the Wi-Fi device is receiving.

4. Enter the network password and touch [OK]. The device will be connected.

If a listed device is in a status capable of making Wi-Fi connection, touching the device name on the list will start the connection.

2. Getting started



INFO:

- Enter the password correctly, including capitalization.
- Touching the will display the network information. Turning [Connect Automatically] on will automatically connect the vehicle to the network if the network is available.
- The system can connect to only WPA2 security network (not connect WEP, WPA1 network).
- Wi-Fi networks that require a web browser cannot be accessed through this units.

Wi-Fi settings:

The Wi-Fi settings can be changed according to your preference.

1. Push **<MENU>** and touch [Connections].
2. Touch [Wi-Fi].
3. Touch .
4. Touch a preferred item.

Available items may vary depending on models, specifications and software versions.

Available setting items

Setting item	Action
[Wi-Fi]	Turns the Wi-Fi connection on/off.
[Vehicle Hotspot]	Turns the vehicle hotspot on/off.
[Network Name (SSID)]	The Wi-Fi network name can be changed.
[Password]	The Wi-Fi network password can be changed.

Deleting Wi-Fi network:

The stored Wi-Fi network can be deleted from the list.

1. Push **<MENU>** and touch [Connections].
2. Touch [Wi-Fi].
3. Touch by the name of the network you wish to delete.
4. Touch [Forget this Network]. Touch [Yes] when a message appears.

Using Wi-Fi hotspot (if so equipped):

The Wi-Fi hotspot function enables you to connect devices such as a laptop computer or a tablet computer to the vehicle. You can access the Internet using TCU (Telematics Control Unit) installed in your vehicle when a

service provider's subscription is active. Up to 7 devices can be connected to the Wi-Fi hotspot.



INFO:

To use the Internet, a subscription with the service provider is required in advance. Consult your cellular provider for details.

1. Push **<MENU>** and touch [Connections].
2. Touch [Wi-Fi].
3. Touch [Vehicle Hotspot]. Network Name (SSID) and password will be displayed.
4. Select the in-vehicle Network Name (SSID) on your device.
5. Enter the network password on the device to connect to the in-vehicle Wi-Fi network.



INFO:

- Enabling the Wi-Fi hotspot functionality of your device may incur additional charges from your cellular provider. Consult your cellular provider contract regarding the communication fee.
- The data transfer may be limited depending on the contents.

- Accessibility may be disabled depending on radio wave reception.
- When the automatic connection is active on your device and the Network Name (SSID) is already registered, turning [Vehicle Hotspot] on will automatically connect the device to the vehicle.
- When using wireless Apple CarPlay® (if so equipped), the Wi-Fi hotspot function cannot be used.
- The other wireless communication may cause interference with the Wi-Fi Hotspot function and a delay may occur.
- When operating the device in the vehicle, always obey the legal requirements in the state or province where you are driving.

Displaying USB device information

The information of the connected USB device can be viewed.

-  "USB memory device player"
(page 3-23)

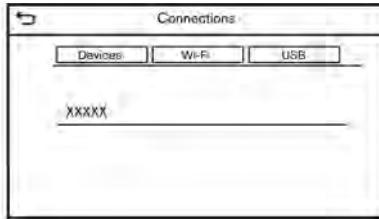

1. Push **<MENU>** and touch [Connections].
2. Touch [USB].
3. Touch the name of the device you wish to check. The name and the type of the device are displayed.

VOLUME AND BEEPS SETTINGS

The volume of various functions including audio, phone, navigation voice guidance (if so equipped), and system beeps can be adjusted.

1. Push **<MENU>** and touch [Settings].
2. Touch [Volume & Beeps].

Available setting items may vary depending on models, specifications and software versions.

Available setting items

Setting item	Action
[Audio Volume]	Adjusts the volume level of the audio system.
[Guidance Volume]	Adjusts the volume level of the guidance voice.
[Ringtone]	Adjusts the volume level of the ringtone of incoming calls.
[Outgoing Call]	Adjusts the volume level of the outgoing calls.
[Button Beeps]	Turns on/off the button beep sound and alarm for prohibited operations.
[Guidance Voice]	Turns on/off the voice guidance.

CLOCK SETTINGS

Clock settings of the system can be changed.

1. Push **<MENU>** and touch [Settings].
2. Touch [Clock].

Available setting items may vary depending on models, specifications and software versions.

2. Getting started

Available setting items

Setting item 1	Setting item 2	Action
[On-Screen Clock]		Sets the clock display on/off. When this item is on, the clock display appears.
[Clock Mode]	[Auto]	Adjusts clock time automatically using GPS.
	[Time Zone]	Adjusts clock time reflecting selected time zone.
	[Manual]	Reflects [Set Clock Manually] settings.
[Clock Format]	[12H]	The clock can be set to 12 hours or 24 hours.
	[24H]	
[Date Format]		The display format of the day, month and year display can be selected.
[Offset (hour)]		Adjusts the offset value (hour/minutes). [Clock Mode] must be set to [Auto] or [Time Zone] for this option to be available.
[Offset (min.)]		
[Daylight Savings Time]		Turns on/off the daylight saving time setting. This option only appears to be available when [Clock Mode] is set to [Time Zone].
[Time Zone]		Select an appropriate time zone from the list. [Clock Mode] must be set to [Time Zone] for this option to be available.
[Set Clock Manually]		Adjusts the clock manually. Touch [+] or [-] to adjust the hours, minutes, day, month and year up or down. When [Clock Format] is set to [12H], [AM]/[PM] can be selected. Models with navigation system: [Clock Mode] must be set to [Manual] for this option to be available.

INFO:

- When the [On-Screen Clock] setting is turned on, the clock settings screen can also be displayed by touching the clock at the upper right corner of the screen.
- Depending on the models, the clock setting of the vehicle information display will also change when the setting of the clock displayed on the touch screen display is changed.

SCREEN SETTINGS

This menu turns on and off the display and adjusts the image quality of the upper display and the lower display.

1. Push **<MENU>** and touch [Settings].
2. Touch [Screen].
3. Touch a preferred adjustment item and adjust to the preferred setting.

Available setting items and functions may vary depending on models, specifications and software versions.



Available setting items

[Display Settings]	Adjusts the image quality of the display.  "Display Settings" (page 2-33)
--------------------	---

[Display]	Turns the display on or off. The display also can be turned on or off by pushing and holding <MENU> . When the display is turned off, push and hold <CAMERA  <*/> (models with Around View® Monitor system) or <*/> (models without Around View® Monitor system) to turn the display on.
[Day/Night]	Adjusts the display brightness and toggles the map color between the day screen and night screen.
[Change Map Color]	Toggles the map color between the day screen and night screen.
[Reset Settings]	This restores the display settings to the default settings.

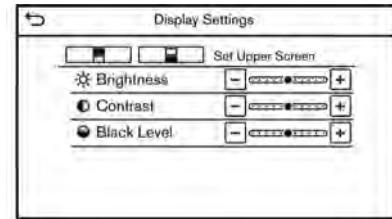
Display Settings



1. Push **<MENU>** and touch [Settings].
2. Touch [Screen] and touch [Display Settings].
3. Select the display to be changed.
 -  : Set upper display.
 -  : Set lower display.

2. Getting started

Available setting items

[Brightness]	Adjust the display brightness.
[Contrast]	Adjust the display contrast.
[Black Level]	Adjust the display black level.

LANGUAGE SETTING

This changes the language used in the system.

1. Push **<MENU>** and touch [Settings].
2. Touch [Others].
3. Touch [Language].

Selects the preferred system language.

The language setting is applied to the upper display and the lower display, voice announcements and the Voice Recognition System.



INFO:

- Do not change the position of the ignition switch while changing the language.
- If the selected language is also supported in the vehicle information display, a confirmation message asking if you would like to also change the meter language is displayed. Select [Yes] to

change the language in the vehicle information display.

UNITS SETTINGS

This changes the units used in the system.

1. Push **<MENU>** and touch [Settings].
2. Touch [Others].
3. Touch [Units].

Available setting items may vary depending on models, specifications and software versions.

Available setting items

Setting item	Action
[Distance]	Select the distance unit.
[Fuel Economy]	Select the fuel economy unit.
[Temperature]	Select the temperature unit.



INFO:

- Do not change the position of the ignition switch while changing the units.
- The unit displayed on the vehicle information display and meter will also change with the units displayed on the

upper and lower displays.

KEYBOARD TYPE SETTINGS

The keyboard layout of the character input screens can be selected.

1. Push **<MENU>** and touch [Settings].
2. Touch [Others].
3. Touch [Keyboard Type]. The type of keyboard switches between ABC and QWERTY.

RETURN ALL SETTINGS TO DEFAULT

This resets all settings to default.

1. Push **<MENU>** and touch [Settings].
2. Touch [Others].
3. Touch [Return All Settings to Default].
4. A confirmation message is displayed. Touch [Yes] to set the settings to default.

QUICK SETTING MENU SCREEN

Touch  on the lower display to set the display of the setting menu items.

Available setting items

Setting item	Action
[Day/ Night]	Adjust the upper and lower display brightness. Toggle the map color (if so equipped) between the day screen and night screen.
[Bass]	Adjust the speaker tone quality and sound balance by touching [+]/[-], [L]/[R] or [R]/[F].
[Treble]	
[Balance]	
[Fade]	
[Volume & Beeps]	This turns on and off, as well as adjusts, the volume for various functions including, phone, navigation voice guidance (if so equipped), as well as system beeps.  "Volume and Beeps settings" (page 2-31)

2. Getting started

MEMO

3 Audio system

Audio operation precautions	3-2	Radio	3-14
Radio	3-2	Compact Disc (CD) player (if so equipped)	3-21
Compact Disc (CD)	3-4	USB memory device player	3-23
USB (Universal Serial Bus) connection port	3-5	iPod® player	3-26
Compressed Audio Files (MP3/WMA/AAC)	3-6	Bluetooth® audio	3-30
Bluetooth® audio	3-10	Auxiliary (AUX) devices (if so equipped)	3-33
Names and functions of audio control buttons	3-11	Smartphone audio	3-34
Audio main buttons	3-11	Audio settings	3-35
Steering wheel mounted audio control	3-12	CD/USB memory device care and cleaning	3-36
Audio operations	3-12	CD (if so equipped)	3-36
Audio main operation	3-12	USB memory device	3-36

3. Audio system

AUDIO OPERATION PRECAUTIONS

CAUTION

- Operate the audio system only when the vehicle engine is running. Operating the audio system for extended periods of time with the engine turned off can discharge the vehicle battery.
- Do not allow the system to get wet. Excessive moisture such as spilled liquids may cause the system to malfunction.

RADIO

Place the ignition switch in the ACC or ON position before turning on the radio. If you listen to the radio with the engine not running, the ignition switch should be placed in the ACC position.

Radio reception is affected by station signal strength, distance from radio transmitter, buildings, bridges, mountains and other external influences. Intermittent changes in reception quality normally are caused by these external influences.

Using a cellular phone in or near the vehicle may influence radio reception quality.

Radio reception

Your radio system is equipped with state-of-the-art electronic circuits to enhance radio reception. These circuits are designed to extend reception range, and to enhance the quality of that reception.

However there are some general characteristics of both FM and AM radio signals that can affect radio reception quality in a moving vehicle, even when the finest equipment is used. These characteristics are completely normal in a given reception area, and do not indicate any malfunction in your radio system.

Reception conditions will constantly change because of vehicle movement. Buildings, terrain, signal distance and interference from other vehicles can work against ideal reception. Described below are some of the factors that can affect your radio reception.

Some cellular phones or other devices may cause interference or a buzzing noise to come from the audio system speakers. Storing the device in a different location may reduce or eliminate the noise.

FM radio reception

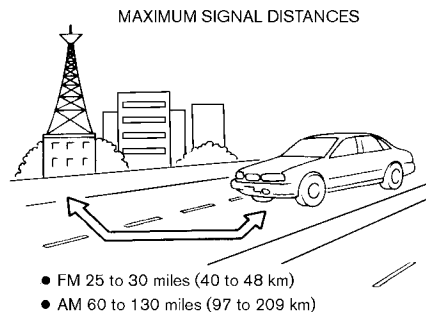

Range: the FM range is normally limited to 25 to 30 miles (40 to 48 km), with monaural (single station) FM having slightly more range than stereo FM. External influences may sometimes interfere with FM station reception even if the FM station is within 25 miles (40 km). The strength of the FM signal is directly related to the distance between the transmitter and receiver. FM signals follow a line-of-sight path, exhibiting many of the same characteristics as light. For example, they will reflect off objects.

Fade and drift: As your vehicle moves away

from a station transmitter, the signals will tend to fade and/or drift.

Static and flutter: During signal interference from buildings, large hills or due to antenna position, usually in conjunction with increased distance from the station transmitter, static or flutter can be heard. This can be reduced by lowering the treble setting to reduce the treble response.

Multipath reception: Because of the reflective characteristics of FM signals, direct and reflected signals reach the receiver at the same time. The signals may cancel each other, resulting in momentary flutter or loss of sound.

AM radio reception

AM signals, because of their low frequency, can bend around objects and skip along the ground. In addition, the signals can bounce off the ionosphere and be bent back to earth. Because of these characteristics, AM signals are also subject to interference as they travel from transmitter to receiver.

Fading: Occurs while the vehicle is passing through freeway underpasses or in areas with many tall buildings. It can also occur for several seconds during ionospheric turbulence even in areas where no obstacles exist.

Static: Caused by thunderstorms, electrical power lines, electric signs and even traffic lights.

HD Radio™ Technology reception

HD Radio Technology reception needs to be activated to receive HD Radio broadcasts.

 "Radio Menu" (page 3-18)

This enables you to receive radio broadcasts digitally (where available), providing a better quality sound with clear reception. When this feature is not activated or HD Radio broadcasts are not available, you will receive analog radio (AM/FM) broadcasts.

Satellite radio reception

When the satellite radio is used for the first time or the battery has been replaced, the satellite radio may not work properly. This is not a malfunction. Wait more than 10 minutes with the satellite radio ON and the vehicle outside of any metal or large building for the satellite radio to receive all of the necessary data.

SiriusXM® services require a subscription after trial period and are sold separately or as a package. The satellite service is available only in the 48 contiguous USA and DC. SiriusXM® service is also available in Cana-

da; see www.siriusxm.ca.

The satellite radio performance may be affected if cargo carried on the roof blocks the satellite radio signal.

If possible, do not put cargo near the satellite antenna.

A buildup of ice on the satellite radio antenna can affect satellite radio performance. Remove the ice to restore satellite radio reception.

3. Audio system

COMPACT DISC (CD)

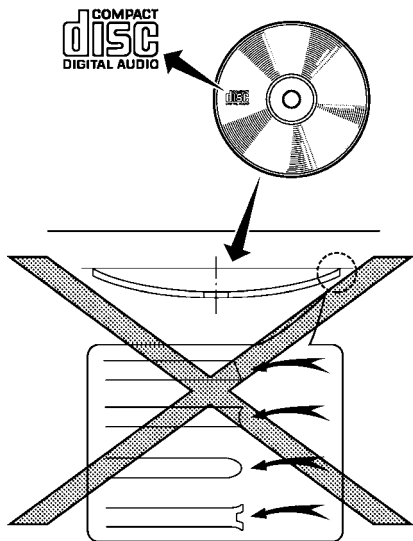

- Do not force a CD into the CD slot. This could damage the CD and/or CD player.
- Trying to load a CD with the CD door closed could damage the CD and/or CD player.
- During cold weather or rainy days, the player may malfunction due to the humidity. If this occurs, remove the CD and dehumidify or ventilate the player completely.
- The player may skip while driving on rough roads.
- The CD player sometimes cannot function when the passenger compartment temperature is extremely high. Decrease the temperature before use.
- Only use high quality 4.7 in (12 cm) round discs that have the "COMPACT disc DIGITAL AUDIO" logo on the disc or packaging.
- Do not expose the CD to direct sunlight.
- CDs that are of poor quality, dirty, scratched, covered with fingerprints or that have pin holes may not work properly.
- The following CDs may not work properly:
 - Copy control compact discs (CCCD)
 - Recordable compact discs (CD-R)
 - Rewritable compact discs (CD-RW)
- Do not use the following CDs as they may cause the CD player to malfunction.
 - 3.1 in (8 cm) discs
 - CDs that are not round
 - CDs with a paper label
 - CDs that are warped, scratched, or have abnormal edges
- This audio system can only play prerecorded CDs. It has no capabilities to record or burn CDs.
- If the CD cannot be played, one of the following messages will be displayed.
 - Disc read error:**
Indicates a CLV, Focus, TOC or Access error. Check and reinsert the CD. Make sure that it is inserted correctly.
 - Please eject disc:**
Indicates a mechanism error. If the CD can be ejected, eject and reinsert the CD. If the CD cannot be ejected, it is recommended you visit an INFINITI retailer for service.

Unplayable file:

Indicates that a readable file is not found on the inserted CD. Check the data in your CD.

USB (Universal Serial Bus) CONNECTION PORT



WARNING

Do not connect, disconnect or operate the USB device while driving. Doing so can be a distraction. If distracted you could lose control of your vehicle and cause an accident or serious injury.



CAUTION

- **Do not force the USB device into the USB connection port. Depending on the USB connection port, inserting the USB device tilted or upside down may damage the port. Make sure that the USB device is connected correctly into the USB connection port.**
- **Do not grab the USB connection port cover (if so equipped) when pulling the USB device out of the port. This could damage the port and the cover.**

- **Do not leave the USB cable in a place where it can be pulled unintentionally. Pulling the cable may damage the port.**

The vehicle is not equipped with a USB device. USB devices should be purchased separately as necessary.

This system cannot be used to format USB devices. To format a USB device, use a personal computer.

This system supports various USB memory devices, USB hard drives and iPod® players. Some USB devices may not be supported by this system.

- Partitioned USB devices may not be played correctly.
- Some characters used in other languages (Chinese, Japanese, etc.) are not displayed properly on the display. Using English language characters with a USB device is recommended.

General notes for USB use:

Refer to your device manufacturer's owner information regarding the proper care of the device.

Notes for iPod® use:

iPod® is a trademark of Apple Inc., registered in the U.S. and other countries.

- Improperly plugging in the iPod® may cause a checkmark to be displayed on and off (flickering). Always make sure that the iPod® is connected properly.
- Audiobooks may not play in the same order as they appear on an iPod®.

3. Audio system

COMPRESSED AUDIO FILES (MP3/WMA/AAC)

Explanation of terms

- MP3 – MP3 is short for Moving Pictures Experts Group Audio Layer 3. MP3 is the most well-known compressed digital audio file format. This format allows for near “CD quality” sound, but at a fraction of the size of normal audio files. MP3 conversion of an audio track can reduce the file size by approximately a 10:1 ratio (Sampling: 44.1 kHz, Bit rate: 128 kbps) with virtually no perceptible loss in quality. The compression reduces certain parts of sound that seem inaudible to most people.
- WMA – Windows Media Audio (WMA) is a compressed audio format created by Microsoft as an alternative to MP3. The WMA codec offers greater file compression than the MP3 codec, enabling storage of more digital audio tracks in the same amount of space when compared to MP3s at the same level of quality.

This product is protected by certain intellectual property rights of Microsoft Corporation and third parties. Use or

distribution of such technology outside of this product is prohibited without a license from Microsoft or an authorized Microsoft subsidiary and third parties.

- Bit rate – Bit rate denotes the number of bits per second used by a digital music file. The size and quality of a compressed digital audio file is determined by the bit rate used when encoding the file.
- Sampling frequency – Sampling frequency is the rate at which the samples of a signal are converted from analog to digital (A/D conversion) per second.
- Multisession – Multisession is one of the methods for writing data to media. Writing data once to the media is called a single session, and writing more than once is called a multisession.
- ID3/WMA tag – The ID3/WMA tag is the part of the encoded MP3 or WMA file that contains information about the digital music file such as song title, artist, album title, encoding bit rate, track time duration, etc. ID3 tag information is displayed on the Album/Artist/Track title line on the display.

- AAC – Advanced Audio Coding (AAC) is a compressed audio format. AAC offers greater file compression than MP3 and enables music file creation and storage at the same quality as MP3.

* Windows® and Windows Media® are registered trademarks or trademarks of Microsoft Corporation in the United States of America and/or other countries.

Playback order

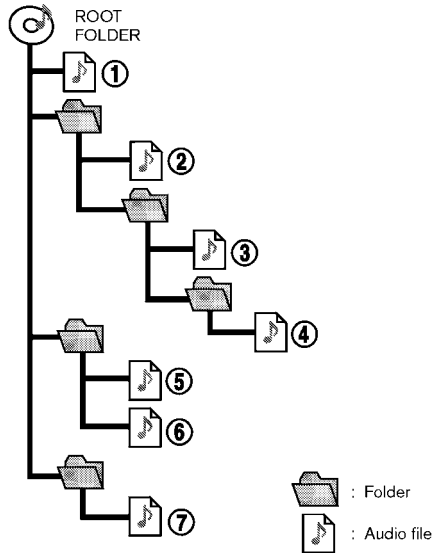

software, so the files might not play in the desired order.

- Music playback order of compressed audio files is as illustrated.

- The folder names of folders not containing compressed audio files are not shown on the display.
- The playback order is the order in which the files were written by the writing

3. Audio system

Specification chart for CD (if so equipped)

Supported media		CD, CD-R*5, CD-RW*5	
Supported file systems		CD, CD-R*5, CD-RW*5	
Supported versions*1	MP3	Version	MPEG1 Audio Layer3, MPEG2 Audio Layer3
		Sampling frequency	MPEG1 Audio Layer3: 32kHz, 44.1kHz, 48kHz MPEG2 Audio Layer3: 16kHz, 22.05kHz, 24kHz
		Bit rate	MPEG1 Audio Layer3: 32 kbps - 320 kbps MPEG2 Audio Layer3: 8 kbps - 160 kbps
	WMA*2	Version	WMA7, WMA8, WMA9, WMA9.1, WMA9.2
		Bit rate/Sampling frequency	Bit rate: Ver7, Ver8: 32-192kbps Ver9, Ver9.1, Ver9.2: 32-192kbps, VBR Sampling frequency: Ver7, Ver8: 8k/11.025k/16k/22k/32k/44.1k Ver9, Ver9.1, Ver9.2: 8k/11.025k/16k/22k/32k/44.1k/48 kHz
	AAC*3	Bit rate/Sampling frequency	Bit rate: 8-256 kbps, VBR Sampling frequency: 11.025-48kHz
Tag information (Song title, Artist name and Album name)		ID3 tag VER1.0, VER1.1, VER2.2, VER2.3, VER2.4 (MP3 only) WMA tag (WMA only) AAC tag (AAC only)	
Folder levels		CD, CD-R*5, CD-RW*5: Folder levels: 8, Folders: 255 (including root folder), Files: 510 (Max. 255 files for one folder)	
Displayable character codes*4		01: SHIFT-JIS, ASCII, ISO-8859-1, UTF-8, UTF-16 BOM, UTF-16 Big Endian, UTF-16 Little Endian, 02: UNICODE, 03: UTF-16	

*1 Files created with a combination of 48 kHz sampling frequency and 64 kbps bit rate cannot be played.

*2 Protected WMA files (DRM) cannot be played.

*3 Made by iTunes.

*4 Available codes depend on what kind of media, versions and information are going to be displayed.

*5 May not be operated with the Voice Recognition System.

 "7. Voice recognition"

Specification chart for USB

Supported media	USB2.0
Supported file systems	FAT16, FAT32
Folder levels	Folder levels: 8, Files via folder: 255, Folders: 512 (including root folder), Files: 8000
Tag information (Song title, Artist name and Album name)	ID3 tag VER1.0, VER1.1, VER2.2, VER2.3, VER2.4 (MP3 only)
	WMA tag (WMA only)
	AAC tag (AAC only)

Format			Sampling frequency	Supported bitrate
MP3 *1	MPEG1	Layer-3	32, 44.1, 48 kHz	32-320 kbps
	MPEG2		16, 22.05, 24 kHz	8-160 kbps
WMA *2			8, 11.025, 16, 22.05, 32, 44.1, 48 kHz	12-192 kbps
AAC (MPEG4) *3 (Extension "m4a" only)			11.025, 16, 22.05, 32, 44.1, 48 kHz	8-320 kbps
FLAC			8-192 kHz	128 - 12,288 kbps
Wav			8-192 kHz	128 - 12,288 kbps

*1 MPEG2.5 is not supported.

*2 WMA7, WMA8, WMA9, WMA9.1, WMA9.2 are supported. (WMA9 Professional, Lossless, Voice are not supported.)

*3 Only AAC files encoded by iTunes are supported. HE-AAC (High-Efficiency) is not supported.

3. Audio system

BLUETOOTH® AUDIO

- Some Bluetooth® audio devices may not be recognized by the in-vehicle audio system.
- It is necessary to set up the wireless connection between a compatible Bluetooth® audio device and the in-vehicle Bluetooth® module before using the Bluetooth® audio.
- The Bluetooth® audio may stop playing when
 - receiving a hands-free call.
 - checking the connection to the hands-free phone.
 - connecting the hands-free phone or the audio device.
 - downloading the phonebook memory from the connected cellular phone.
- The Bluetooth® audio may be disconnected if you are using wireless Apple CarPlay® (if so equipped).
 "Apple CarPlay®" (page 5-18)
- Do not place a Bluetooth® audio device in an area surrounded by metal or far away from the in-vehicle Bluetooth® module to prevent tone quality degradation and wireless connection disruption.
- While an audio device is connected through a Bluetooth® wireless connection, the battery of the device may discharge quicker than usual.
- This system supports the Bluetooth® Advanced Audio Distribution Profile (A2DP) and Audio/Video Remote Control Profile (AVRCP).
- Wireless LAN (Wi-Fi) and the Bluetooth® functions share the same frequency band (2.4 GHz). Using the Bluetooth® and the wireless LAN functions at the same time may slow down or disconnect the communication and cause undesired noise. It is recommended that you turn off the wireless LAN (Wi-Fi) when using the Bluetooth® functions.

NAMES AND FUNCTIONS OF AUDIO CONTROL BUTTONS

AUDIO MAIN BUTTONS

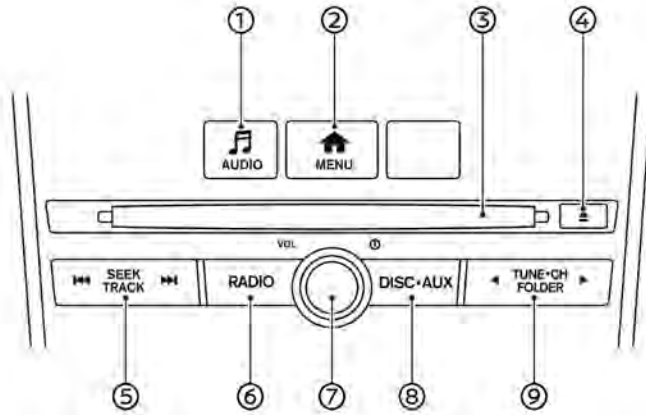

① **<AUDIO>:**

Push to display the audio screen of the previously selected source.

Push again to display the audio source menu screen.

"Selecting audio source" (page 3-13)

② **<MENU>:**

Push this button to go to the menu screen.

③ **CD slot:**

Insert a CD with the label side facing up.

④ **< ▲ >:**

Push to eject a CD.

⑤ **<SEEK-TRACK>:**

Functions to change radio stations/channels or to skip and fast-forward/rewind through tracks.

⑥ **<RADIO>:**

Push to switch to the radio mode. The radio band will shift in the order of AM, FM and SXM® (SiriusXM®) each time the button is pushed.

⑦ **<VOL/ ⏻ >:**

Push to turn on/off the audio system.

The audio system can also be turned on if the button is turned when the audio system is turned off.

Turn to adjust the volume.

⑧ **<DISC-AUX>/<MEDIA>:**

Each time the button is pushed, a different audio source (CD, USB, iPod®, Bluetooth® Audio, AUX (if so equipped) or smartphone audio) will be selected.

⑨ **<TUNE-CH-FOLDER>:**

Functions to manually tune AM/FM, to tune SXM® channels, to fast-forward/rewind tracks and to select MP3/WMA/AAC folders.

3. Audio system

STEERING WHEEL MOUNTED AUDIO CONTROL

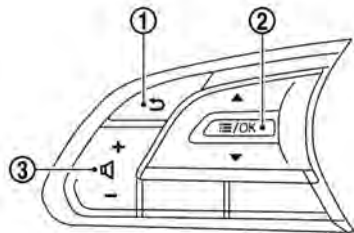

① < ⏪ > (BACK):

Push to go back to the previous screen or cancel the selection if it is not completed.

② < ≡ /OK >:

Tilting the switch up/down while the audio system is turned on with the map (models with navigation system) or displayed feature screen (models without navigation system) displayed on the upper display can operate the audio system such as changing tracks and radio stations.

Tilt and hold to rewind/fast-forward tracks or seek up/down to the next/

previous receivable broadcast station. Push to select audio source or display the audio list from the shortcut menu.

☞ "Shortcut menu" (page 2-12)

③ <- 🔊 +> (Volume control):

Push the "+" or "-" side of the switch to increase or decrease the volume.

AUDIO OPERATIONS

AUDIO MAIN OPERATION

Turning audio system on/off

The ignition switch must be in the ACC or ON position to turn on the audio system. Push <VOL/ 🔊 > or <AUDIO> to turn on the last audio source that was playing immediately before the system was turned off. To turn off the audio system, push <VOL/ 🔊 > again.



INFO:

The audio system can also be turned on by turning <VOL/ 🔊 > when the audio system is turned off.

Selecting audio source

Selecting from source menu screen:

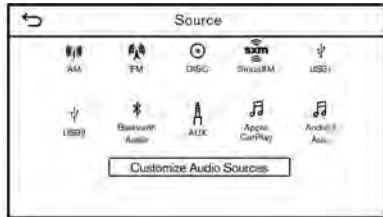

Example

1. Push **<AUDIO>** when the audio screen is displayed.
2. Select an audio source you prefer to play.



INFO:

- Touching [Source] on the upper left corner of the audio screen will also display the audio source menu screen.
- Pushing **<RADIO>** or **<DISC·AUX>/<MEDIA>** can also change the audio source.
]☞ "Audio main buttons" (page 3-11)
- If the audio system has been turned off while the radio, CD, USB memory device or Bluetooth® Streaming Audio device etc., was playing, turning the audio

system back on will play the audio source that was playing when the system was turned off.

- Depending on the models, the audio system settings can be linked and memorized for each of the Intelligent Keys.
]☞ "Fully customizable digital environment" (page 5-29)

Selecting from source bar:



Example

The audio source can also be changed with the source bar on the bottom of the audio screen.

The source icons are displayed on the source bar. Touch the icon to select the preferred audio source.

Customizing source bar:

The items displayed in the source bar can be customized.

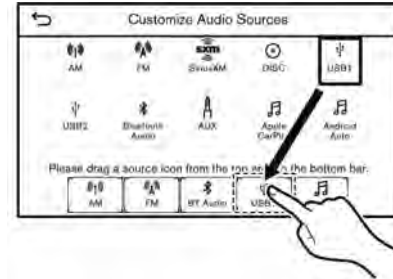

Example

1. Push **<AUDIO>** or touch [Source], while the Audio screen is displayed.
2. Touch [Customize Audio Sources].
3. Drag the preferred source icon to the source bar.
4. Touch [] to confirm the setting.



INFO:

[Customize Audio Sources] can also be accessed from [Settings] on the MENU screen.

]☞ "System settings" (page 2-21)

3. Audio system

RADIO

How to view radio screen

AM/FM screen:

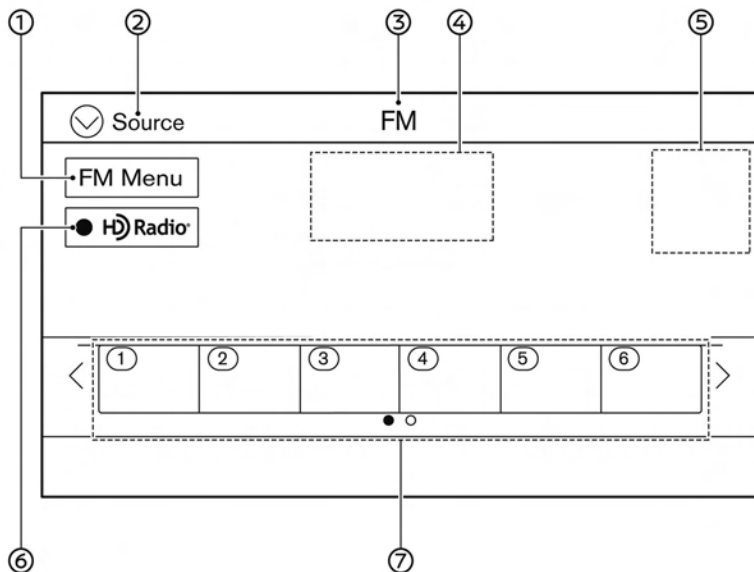

- ① [AM Menu]/[FM Menu]:
Touch to display the radio menu screen.
☞ "Radio Menu" (page 3-18)
- ② [Source]:
Touch to switch to the source menu screen.
☞ "Selecting audio source" (page 3-13)
- ③ Audio source indicator:
Indicates the currently selected audio source.
- ④ Reception information display:
Reception information currently available such as frequency, station name, etc. is displayed.
- ⑤ Album artwork:
When in the HD Radio mode, images or album artworks are displayed by the currently playing station.
- ⑥ HD Radio mode on/off key:
The HD Radio mode turns on and the indicator comes on by touching it while the AM or FM radio screen is displayed.
- ⑦ Preset list:
To listen to a preset station, touch the corresponding station from the preset

list. If displayed, touch [<] or [>] to scroll the preset list.

Touch and hold one of the keys in the preset list to store the currently playing station to that key location.

 "Presetting" (page 3-17)

 **INFO:**

HD Radio reception needs to be enabled to receive HD Radio broadcasts. This enables you to receive radio broadcasts digitally (where available), providing a better quality sound with clear reception. When this feature is not enabled or HD Radio broadcasts are not available, you will receive analog radio (AM/FM) broadcasts.

SiriusXM® screen:

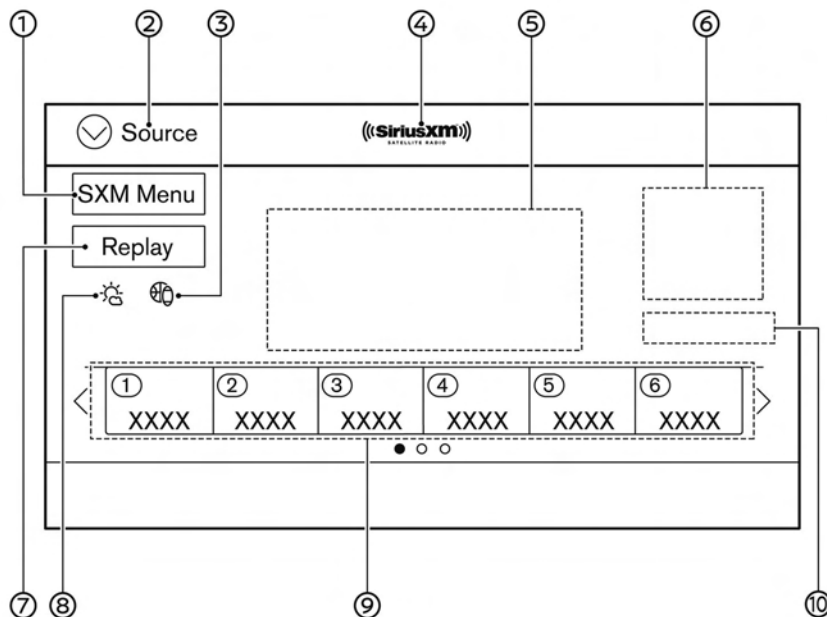

3. Audio system

① [SXM Menu]:

Touch to display the SiriusXM® menu screen.

 "Radio Menu" (page 3-18)

② [Source]:

Touch to switch to the source menu screen.

 "Selecting audio source" (page 3-13)

③ Sports Flash indicator:

An indicator will be displayed when sports information is available for pre-registered sports teams. The indicator color signifies the current status:

Gray	No Sports Flash audio is available yet, or Sports Flash monitoring is deactivated.
White	Sports Flash monitoring is activated, but favorite teams are not playing games.
Light green	Favorite teams are playing games.
Orange	Replaying (listening to) Sports Flash audio.

④ Audio source indicator:

Indicates the currently selected audio source.

⑤ Reception information display:

The channel logo will indicate the currently tuned channel name. Also the channel number, artist and title of the currently played song is displayed.

⑥ Album artwork:

Images or album artwork displayed by the currently playing channel.

⑦ [Replay]:

Up to 60 minutes of the broadcast of the currently playing channel can be replayed. Touching [Presets] will return to current SiriusXM® reception.

⑧ Traffic & Weather Now (TWN) indicator:

An indicator will be displayed when SiriusXM Traffic™ and SiriusXM® Weather information are available for pre-registered cities. The indicator color signifies the current status:

Gray	TWN audio is loading, or no city has been defined yet.
White	Already listened to current TWN audio information.
Light green	New TWN audio information is available.
Orange	Playing TWN audio information.

The information can be played by touching the indicator when the indicator is light green.

⑨ Preset list:

To listen to a preset channel, touch the corresponding channel from the preset list. Touch [<] or [>] to scroll the preset list. Touch and hold one of the keys in the preset list to store the currently playing station to that key location.

 "Presetting" (page 3-17)

⑩ Mode indicator:

Displays the current play mode. "Live Mode" or "Replay Mode" will be displayed.

**INFO:**

The SiriusXM® Radio function will not operate without a subscription to SiriusXM® Radio.

Radio operation**Radio activation and band selection:**

Push **<RADIO>** or select the preferred radio band (AM, FM or SXM®) from the audio source menu to turn on the radio. Each time **<RADIO>** is pushed, the radio band will change.

"Selecting audio source" (page 3-13)

**INFO:**

When the stereo broadcast signal is weak, the radio will automatically change from stereo to monaural reception.

Tuning:**AM/FM**

Tune to stations manually with the following operations.

- Control panel
 - Push **<TUNE·CH·FOLDER>**

SiriusXM® Radio

Tune to channels manually with the following operations.

- Control panel
 - Push **<TUNE·CH·FOLDER>**

Fast tuning:

Fast tune to stations with the following operation.

- Control panel
 - Push and hold **<SEEK·TRACK>**

Seek tuning (AM or FM mode):

Seek up/down to the next/previous receivable broadcast station with the following operations.

- Control panel
 - Push **<SEEK·TRACK>**
- Steering wheel
 - Tilt and hold **< ≡ /OK>**

Direct tuning (SiriusXM® mode):

To directly tune to the preferred channels, touch [Direct Tune] on the [SXM Menu] screen and then enter the radio frequency.

- "How to view radio screen" (page 3-14)
- "Radio Menu" (page 3-18)

Presetting:

Up to 6 for AM, 12 for FM and 18 for SiriusXM® stations/channels can be registered in the preset list.

1. Select a radio band (AM, FM or SiriusXM®).
2. Tune to the station/channel you wish to store.
3. Touch and hold one of the preset numbers in the preset list.

The information such as frequency (AM/FM), channel number (SiriusXM®), etc. will be displayed on the preset list.

Select preset stations with the following operations.

- Steering wheel
 - Tilt **< ≡ /OK>**
- Touch screen
 - Briefly touch a preferred station on the preset list on the radio screen.

3. Audio system

Radio Menu

Touch [FM Menu], [AM Menu], and [SXM Menu] on each radio screen to display the corresponding menu screen.

Available menu items may vary depending on models, specifications and software versions.

[FM Menu]/[AM Menu]:

[SCAN]	To scan tune the stations, touch [FM Menu] or [AM Menu] on the radio screen and then touch [SCAN]. The stations will be tuned from low to high frequencies and stop at each broadcasting station for several seconds. Touching [SCAN] again during this period of several seconds will stop scan tuning and the radio will remain tuned to that station.
[Radio Text]	Displays the radio text information.
[Refresh]	Touch to update the station list displayed on the right side of the FM or AM menu screen.
Station List	Displays the station list on the right side of the FM or AM menu screen.

[SXM Menu]:

[Now Playing]	Touch to display the SiriusXM® screen.
[Channel List]	Touch to display the channel list.
[Direct Tune]	Touch to select a channel by entering channel number directly. Touch [Now Playing] to return to the SiriusXM® screen without any changes.
[Tag Artist]	Touch to save the current artist as a favorite.
[Tag Song]	Touch to save the current song as a favorite.
[Categories]	Touch to select a channel by selecting from the category list.

3. Audio system

[Start Tune Scan]	While the audio system is on, all songs playing on the preset channels are recorded. Up to one hour of music is recorded for each preset channel. Touch to scan play the recorded songs for a few seconds (oldest song is played first). Touch [Play] to stop scanning and select currently played song to replay. Touch [◀◀]/[▶▶] to skip to the next or previous song. Touch [Abort] to cancel the scanning.
[Favorite Artists: History]	Touch to display the favorite artist alert history.
[Favorite Songs: History]	Touch to display the favorite song alert history.
[Sports Flash: History]	Touch to display the sports flash alert history.
[Edit Favorite Artists]	Turn on/off the notification for favorite artists. Touching [Turn All Alerts ON]/[Turn All Alerts OFF] can turn on/off for all artist at once. Touching [🗑️] can delete a stored favorite artist and [Delete All Favorites] deletes all stored artists.
[Edit Favorite Songs]	Turn on/off the notification for favorite songs. Touching [Turn All Alerts ON]/[Turn All Alerts OFF] can turn on/off for all song at once. Touching [🗑️] can delete a stored favorite song and [Delete All Favorites] deletes all stored songs.
[Edit Sports Flash Teams]	Turn on/off the notification for a favorite team. Touching [Turn All Alerts ON]/[Turn All Alerts OFF] can turn on/off for all team at once. Touching [🗑️] can delete a stored favorite team. [Add Team] can add a new favorite team to the list.
[Edit Favorite TWN City]	Touch to select a city from the list. Traffic & Weather Now (TWN) provides the traffic and weather information for the selected city and nearby area by touching the Traffic & Weather Now indicator on the SiriusXM® screen.
[Notification Settings]	Touch to turn on/off the notifications for Artists, Songs, and Sports Flash. Turning on [Alerts on Non-Audio Screens] can also display the notification on menu screens other than the audio screen.
[Customize Channel List]	Touch to customize the channel list. Only the selected channels will be tuned in to when you seek or scan the channels. You can select each item or select [Disable All Channels]/[Enable All Channels]. You can also turn on/off [Mature Channels].

3. Audio system

[Tune Start]	Touch to turn on/off the Tune Start feature. This feature buffers the content playing on each of the SiriusXM® preset channels, so that when a preset channel is selected, the currently playing song always starts playing from the beginning.
--------------	---



INFO:

- SiriusXM® Audio requires a subscription after trial period and are sold separately or as a package. The satellite service is available only in the 48 contiguous USA and DC. SiriusXM® service is also available in Canada; see www.siriusxm.ca.
- It may take some time to receive the activation signal after the initiation of the SiriusXM® Radio subscription. After receiving the activation signal, an available channel list will automatically be updated in the radio. Change the position of the ignition switch from LOCK to ACC to update the SiriusXM® channel list.

COMPACT DISC (CD) PLAYER (if so equipped)

How to view CD screen

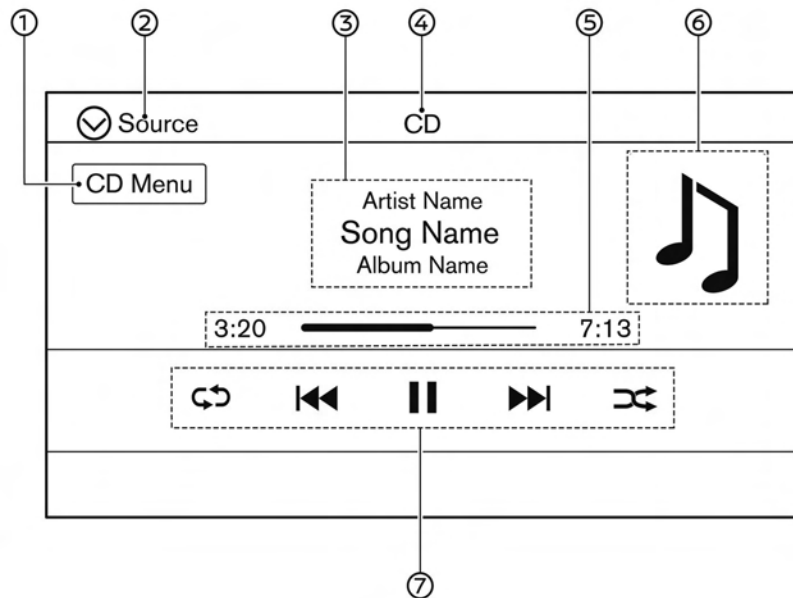

- ① [CD Menu]:
Touch to display the CD Menu screen.
☞ "CD Menu" (page 3-23)
- ② [Source]:
Touch to switch to the source menu screen.
☞ "Selecting audio source" (page 3-13)
- ③ Track information:
Track information such as the song name, artist name and album name are displayed.
- ④ Audio source indicator:
Indicates that CD is the currently selected audio source.
- ⑤ Play time and progress bar:
The play time of the track is displayed. The bar indicates the progress in playing the current track.
- ⑥ Album artwork:
Image of an album artwork is displayed when available if the setting is turned on.
☞ "CD Menu" (page 3-23)
- ⑦ CD operation keys:
Touch to control CD playback functions.

3. Audio system

[↺↻]	Each time [↺↻] is touched, the repeat mode changes. ☞ "Changing play mode" (page 3-22)
[⏮]	Touch once to return to the beginning of the current track. Touch again to select the previous track. Touch and hold to rewind the current track.
[▶]	Touch to play the track.
[⏸]	Touch to pause the track.
[⏭]	Touch to select the next track. Touch and hold to fast-forward the track.
[⏮↻]	Each time [⏮↻] is touched, the random mode changes. ☞ "Changing play mode" (page 3-22)

CD player operation

Loading:

Insert a CD into the slot with the label side facing up. The CD will be guided automatically into the slot and start playing.

Activation and playing:

The CD mode can also be selected from the source menu or by pushing <DISC-AUX>/

3-22

<MEDIA> with a CD loaded to play the CD.

☞ "Selecting audio source" (page 3-13)

☞ "Audio main buttons" (page 3-11)

Skipping tracks:

Skip the tracks with the following operations.

- Control panel
 - Push <SEEK-TRACK>
- Steering wheel
 - Tilt <≡ /OK>
- Touch screen
 - Touch [⏮]/[⏭]



INFO:

Depending on the condition, skipping to the previous track may require pushing the button or touching the key twice. Pushing the button or touching the key once may only restart the current track from the beginning.

Changing folders:

To change folders, touch [CD Menu].

☞ "CD Menu" (page 3-23)

Skip to different folders with the following operation. If no folders are found, tracks will

be skipped.

- Control panel
 - Push <TUNE-CH-FOLDER>

Rewinding/fast-forwarding:

Rewind or fast-forward the track with the following operations.

- Control panel
 - Push and hold <SEEK-TRACK>
- Steering wheel
 - Tilt and hold <≡ /OK>
- Touch screen
 - Touch and hold [⏮]/[⏭]

Changing play mode:

Repeat mode

Touch [↺↻] on the CD screen to change the repeat mode. The following modes are available.

- **CD**
 - [All]: Repeat Album
 - [Track]: Repeat track
 - No text displayed: Repeat off
- **CD with compressed audio files**
 - [All]: Repeat all
 - [Folder]: Repeat folder/sub-folder

[Track]: Repeat track
 No text displayed: Repeat off

Random mode

Touch [↔] on the CD screen to change the random mode.

No text displayed: Random off

[Random]: Random play

Ejecting CD:

Push < ▲ > to eject a CD. If the CD is ejected and left unremoved, it will be reloaded into the slot for protection.



INFO:

The ignition switch must be placed in the ACC or ON position in order for the CD to eject.

CD Menu

Touch [CD Menu] on the CD screen to display the CD menu screen.

The following items are available.

[Now Play-ing]	Touch to display the CD screen.
----------------	---------------------------------

Folder* and track list	The track list for the selected folder is displayed. The name of sub folder is displayed on the top of the list if the sub folder is included in the selected folder. Touch an item on the list to select the folder or track. Touch [⏪] and go back to the previous screen.
------------------------	--

*: Displayed only when available.

USB MEMORY DEVICE PLAYER

Connecting USB memory device



WARNING

Do not connect, disconnect or operate the USB device while driving. Doing so can be a distraction. If distracted you could lose control of your vehicle and cause an accident or serious injury.



CAUTION

- Do not force the USB device into the USB connection port. Depending on the USB connection port, inserting the USB device tilted or upside down

may damage the port. Make sure that the USB device is connected correctly into the USB connection port.

- Do not grab the USB connection port cover (if so equipped) when pulling the USB device out of the port. This could damage the port and the cover.
- Do not leave the USB cable in a place where it can be pulled unintentionally. Pulling the cable may damage the port.

Refer to your device manufacturer's owner information regarding the proper use and care of the device.

When compatible storage devices are plugged into the port, compatible audio files on the storage devices can be played through the vehicle's audio system.

For the location of the USB connection ports:

- 📖 "USB (Universal Serial Bus) connection ports and AUX (auxiliary) input jack" (page 2-7)
- 📖 "USB connection ports" (page 2-8)

3. Audio system

How to view USB screen

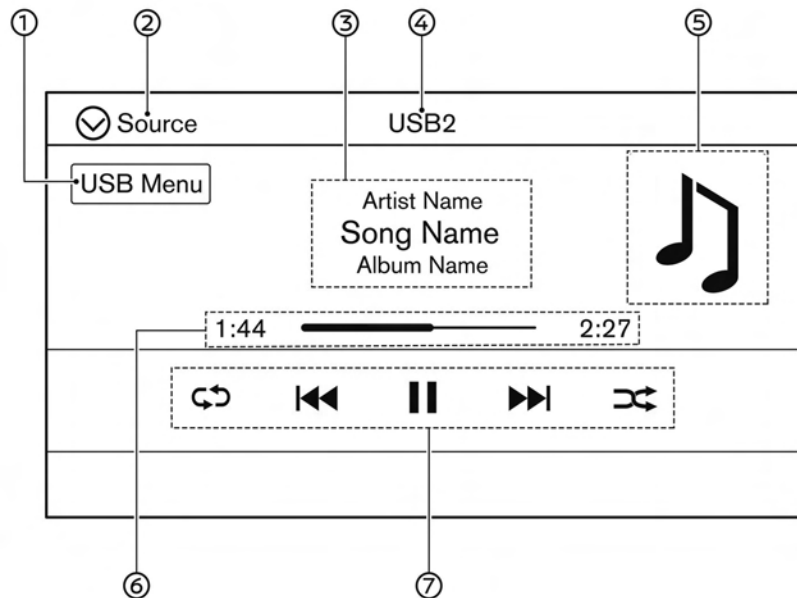

- ① [USB Menu]:
Touch to switch to the USB Menu screen.
☞ "USB Menu" (page 3-26)
- ② [Source]:
Touch to switch to the source menu screen.
☞ "Selecting audio source" (page 3-13)
- ③ Track information:
Track information such as the song name, artist name and album name are displayed.
- ④ Device name indicator:
Indicates the name of the USB device currently playing.
☞ "Selecting audio source" (page 3-13)
- ⑤ Album artwork:
Image of an album artwork is displayed when available if the setting is turned on.
☞ "USB Menu" (page 3-26)
- ⑥ Play time and progress bar:
The play time of the track is displayed. The bar indicates the progress in playing a track.

⑦ USB operation keys:

Touch to control USB playback functions.

[↺]	Each time [↺] is touched, the repeat mode changes. ☞ "Changing play mode" (page 3-25)
[⏮]	Touch to return to the beginning of the current track. Touch again to select the previous track. Touch and hold to rewind the current track.
[▶]	Touch to play the track.
[⏸]	Touch to pause the track.
[⏭]	Touch to select the next track. Touch and hold to fast-forward the track.
[⌂]	Each time [⌂] is touched, the random mode changes. ☞ "Changing play mode" (page 3-25)

USB memory device player operation

Activation and playing:

USB memory device can be played by selecting the source on the audio source

menu screen or by pushing <DISC-AUX>/<MEDIA>.

☞ "Selecting audio source" (page 3-13)

☞ "Audio main buttons" (page 3-11)

Selecting search method:

A list of search methods is displayed in the USB menu.

☞ "USB Menu" (page 3-26)

Skipping tracks:

Skip the tracks with the following operations.

- Control panel
 - Push <SEEK-TRACK>
- Steering wheel
 - Tilt <≡ /OK>
- Touch screen
 - Touch [⏮]/[⏭]



INFO:

Depending on the condition, skipping to the previous track may require pushing the button or touching the key twice. Pushing the button or touching the key once may only restart the current track from the beginning.

Changing folders:

To change folders, touch [USB Menu].

☞ "USB Menu" (page 3-26)

Push <TUNE-CH-FOLDER> to skip to different folders.

Rewinding/fast-forwarding:

Rewind or fast-forward the track with the following operations.

- Control panel
 - Push and hold <SEEK-TRACK>
- Steering wheel
 - Tilt and hold <≡ /OK>
- Touch screen
 - Touch and hold [⏮]/[⏭]

Changing play mode:

Repeat mode

Touch [↺] on the USB screen to change the repeat mode. The following modes are available.

No text displayed: Repeat off

[All]: Repeat all

[Folder]: Repeat folder/sub-folder

[Track]: Repeat track

3. Audio system

Random mode

Touch [∞] on the screen to change the random mode as follows.

No text displayed: Random off

[Random]: Random play

USB Menu

Touch [USB Menu] on the USB screen to display the USB Menu screen.

The following items are available.

[Now Playing]	Touch to display the USB screen.
[Folder List] *	Touch to display the folder list. Touch an item on the list to select the folder. The sub-folder or track list will be displayed. Select a sub-folder or track from the list.
[Album Artwork]	Touch to turn on/off the album artwork display on the USB screen.

[Playlists]	Touch to display the list according to the selected item.
[Artists]	
[Albums]	
[Songs]	
[Genres]	
[Composers]	

*: Displayed only when available.

iPod® PLAYER

Connecting iPod®



WARNING

Do not connect, disconnect or operate the USB device while driving. Doing so can be a distraction. If distracted you could lose control of your vehicle and cause an accident or serious injury.



CAUTION

- **Do not force the USB device into the USB connection port. Depending on the USB connection port, inserting the USB device tilted or upside down may damage the port. Make sure that**

the USB device is connected correctly into the USB connection port.

- **Do not grab the USB connection port cover (if so equipped) when pulling the USB device out of the port. This could damage the port and the cover.**
- **Do not leave the USB cable in a place where it can be pulled unintentionally. Pulling the cable may damage the port.**

Connect the iPod® to the USB connection port.

 "USB (Universal Serial Bus) connection ports and AUX (auxiliary) input jack" (page 2-7)

 "USB connection ports" (page 2-8)

The battery of the iPod® will be charged while the device is connected to the vehicle if the iPod® supports charging via a USB connection.

Depending on the device and iOS, the display on the iPod® shows an INFINITI or Accessory Attached screen when the connection is completed. When the iPod® is connected to the vehicle, the iPod® music library can only be operated by the vehicle audio controls.

iPod® is a trademark of Apple Inc., registered in the U.S. and other countries.

Compatibility:

Made for

- iPhone® 12 Pro Max
- iPhone® 12 Pro
- iPhone® 12 mini
- iPhone® 12
- iPhone® 11 Pro Max
- iPhone® 11 Pro
- iPhone® 11
- iPhone® XR
- iPhone® XS Max
- iPhone® XS
- iPhone® X
- iPhone® 8 Plus
- iPhone® 8
- iPhone® 7 Plus
- iPhone® 7
- iPhone® 6s Plus

- iPhone® 6s
- iPhone® SE (2nd generation)
- iPhone® SE (1st generation)
- iPod touch® (7th generation)



INFO:

- Make sure that iOS is updated.
- Refer to your device manufacturer's owner information regarding the proper use and care of the device.

3. Audio system

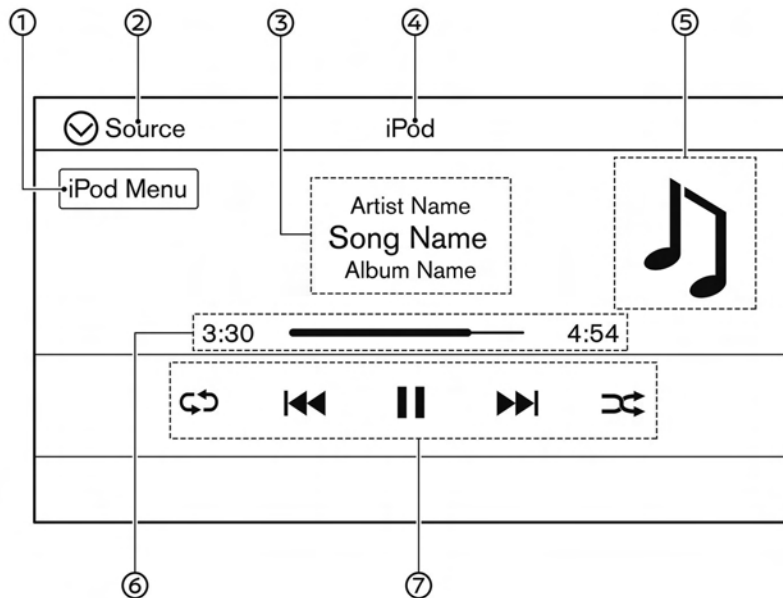

How to view iPod® screen



- ① [iPod Menu]:
Touch to display the iPod® Menu screen.
👉 "iPod® Menu" (page 3-30)
- ② [Source]:
Touch to switch to the source menu screen.
👉 "Selecting audio source" (page 3-13)
- ③ Track information:
Track information such as the song name, artist name and album name are displayed.
- ④ Device name indicator:
Indicates the name of the iPod® currently playing.
- ⑤ Album artwork:
Image of an album artwork is displayed when available if the setting is turned on.
👉 "iPod® Menu" (page 3-30)
- ⑥ Play time and progress bar:
The play time of the track is displayed. The progress bar indicates the progress in playing the current track.

⑦ iPod® operation keys:

Touch to control iPod® playback functions.

[↻]	Each time [↻] is touched, the repeat mode changes.  "Changing play mode" (page 3-29)
[⏮]	Touch to return to the beginning of the current track. Touch again to select the previous track. Touch and hold to rewind the current track.
[▶]	Touch to play the track.
[⏸]	Touch to pause the track.
[⏭]	Touch to select the next track. Touch and hold to fast-forward the track.
[⌂]	Each time [⌂] is touched, the random mode changes.  "Changing play mode" (page 3-29)

iPod® player operation

Depending on the connected device, some functions cannot be used.

Activation and playing:

The iPod® can be played by selecting the source on the audio source menu screen or by pushing <DISC·AUX>/<MEDIA>.

 "Selecting audio source" (page 3-13)

 "Audio main buttons" (page 3-11)

Selecting search method:

A list of search methods is displayed in the iPod® menu.

 "iPod® Menu" (page 3-30)

Skipping tracks:

Skip the tracks with the following operations.

- Control panel
 - Push <SEEK·TRACK>
- Steering wheel
 - Tilt < ≡ /OK>
- Touch screen
 - Touch [⏮]/[⏭]



INFO:

Depending on the condition, skipping to the previous track may require pushing the button or touching the key twice. Pushing the button or touching the key once may

only restart the current track from the beginning.

Rewinding/fast-forwarding:

Rewind or fast-forward the track with the following operations.

- Control panel
 - Push and hold <SEEK·TRACK>
- Steering wheel
 - Tilt and hold < ≡ /OK>
- Touch screen
 - Touch and hold [⏮]/[⏭]

Changing play mode:

Repeat mode

Touch [↻] on the iPod® screen to change the repeat mode. The following modes are available.

No text displayed: Repeat off

[All]: Repeat all

[Track]: Repeat track

3. Audio system

Random mode

Touch [>] on the screen to change the random mode as follows.

No text displayed: Random off

[Random]: Random play

iPod® Menu

Touch [iPod Menu] on the iPod® screen to display the iPod® menu screen.

The following items are available.

[Now Playing]	Touch to display the iPod® screen.
[Current List]	A list of tracks in the currently selected category is displayed.
[Album Artwork]	Touch to turn on/off the album artwork display on the iPod® screen.

[Playlists]	Touch to display the list according to the selected item.
[Artists]	
[Albums]	
[Songs]	
[Genres]	
[Composers]	
[Audiobooks]	
[Podcasts]	

BLUETOOTH® AUDIO

Your vehicle is equipped with Bluetooth® Audio.

If you have a compatible Bluetooth® device with streaming audio capability (A2DP profile), you can set up a wireless connection between your Bluetooth® device and the in-vehicle audio system. This connection allows you to listen to the audio from the Bluetooth® device using your vehicle speakers. It also may allow basic control of the device for playing and skipping audio files using the AVRCP Bluetooth® profile. Not all Bluetooth® devices have the same level of controls for AVRCP. Please consult the manual for your Bluetooth® device for more details.

Wireless LAN (Wi-Fi) and the Bluetooth®

functions share the same frequency band (2.4 GHz). Using the Bluetooth® and the wireless LAN functions at the same time may slow down or disconnect the communication and cause undesired noise. It is recommended that you turn off the wireless LAN (Wi-Fi) when using the Bluetooth® functions.

Connecting Bluetooth® audio device

A Bluetooth® audio device must be connected to the vehicle before operation.

 "Setting devices" (page 2-27)

How to view Bluetooth® audio screen

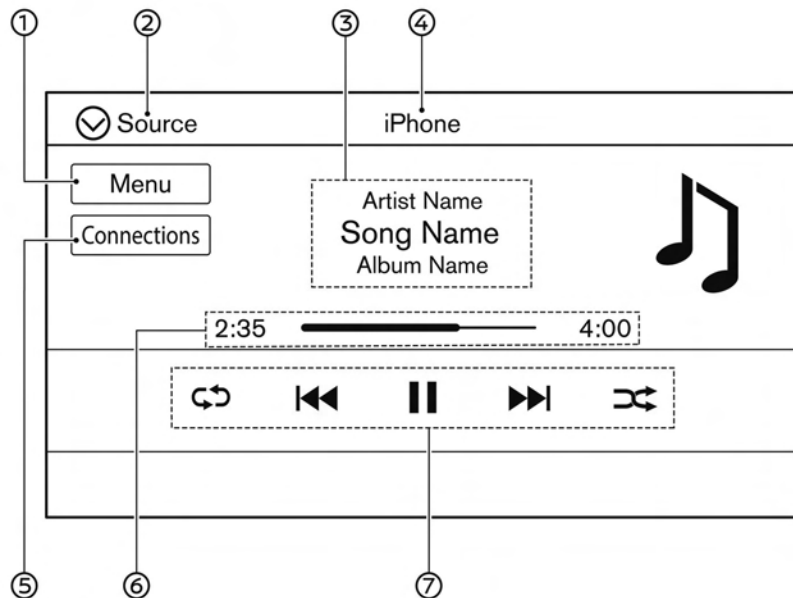

- ① [Menu]:
Touch [Menu] to display the Bluetooth® audio menu screen.
☞ "Bluetooth® menu" (page 3-33)
- ② [Source]:
Touch to switch to the source menu screen.
☞ "Selecting audio source" (page 3-13)
- ③ Track information:
Track information such as the song name, artist name and album name are displayed.
- ④ Device name indicator:
Indicates the name of the Bluetooth® audio device currently playing.
- ⑤ [Connections]:
Touch to display the Connections screen.
☞ "Connections settings" (page 2-27)
- ⑥ Play time and Progress bar:
The play time of the track is displayed. The Progress bar indicates the progress in playing the current track.
- ⑦ Bluetooth® audio operation keys:
Touch to control the Bluetooth® audio

3. Audio system

playback function.

[↺]	Each time [↺] is touched, the repeat mode changes. "Changing play mode" (page 3-33)
[⏮]	Touch to return to the beginning of the current track. Touch again to select the previous track. Touch and hold to rewind the current track.
[▶]	Touch to play the track.
[⏸]	Touch to pause the track.
[⏭]	Touch to select the next track. Touch and hold to fast-forward the track.
[↻]	Each time [↻] is touched, the random mode changes. "Changing play mode" (page 3-33)



INFO:

Depending on the audio device that is connected to the vehicle, track information may not be displayed.

Bluetooth® audio operation

The ability to pause, change tracks, fast forward, rewind, randomize and repeat music may be different between devices. Some or all of these functions may not be supported on each device.



INFO:

Depending on the Bluetooth® audio device that is connected, it may not be possible to perform audio operations or a delay may occur before music is played back.

Activation and playing:

A Bluetooth® audio device can be played by selecting the source on the audio source menu screen or by pushing **<DISC-AUX>/<MEDIA>**.

"Selecting audio source" (page 3-13)

"Audio main buttons" (page 3-11)

Skipping tracks:

Skip the tracks with the following operations.

- Control panel
 - Push **<SEEK-TRACK>**

- Steering wheel
 - Tilt **<≡ /OK>**
- Touch screen
 - Touch [**⏮**]/[**⏭**]



INFO:

Depending on the condition, skipping to the previous track may require pushing the button or touching the key twice. Pushing the button or touching the key once may only restart the current track from the beginning.

Changing folders:

To change folders, touch [Menu].

"Bluetooth® menu" (page 3-33)

Push **<TUNE-CH-FOLDER>** to skip to different folders.

Rewinding/fast-forwarding:

Rewind or fast-forward the track with the following operations.

- Control panel
 - Push and hold **<SEEK-TRACK>**
- Steering wheel

- Tilt and hold < ≡ /OK>
- Touch screen
 - Touch and hold [⏮]/[⏭]

Changing play mode:

Repeat mode

Touch [⏮] on the screen to change the repeat mode.

Random mode

Touch [⏮] on the screen to change the random mode.



INFO:

Available repeat/random modes change depending on the connected device.

Bluetooth® menu

Touch [Menu] on the Bluetooth® audio screen to display the Bluetooth® audio menu screen.

The following items are available.

[Now Playing]	Touch to display the Bluetooth® audio screen.
[Current List]	A list of tracks in the currently selected folder is displayed.

[Connections]	Touch to display the Connections screen. "Connections settings" (page 2-27)
Folder list*	The track list for the selected folder is displayed. The name of sub folder is displayed on the top of the list if the sub folder is included in the selected folder. Touch an item on the list to select the folder or track. Touch [⏮] and go back to the previous screen.

*: Displayed only when available.



INFO:

Depending on the connected device, [Menu] may not be displayed.

AUXILIARY (AUX) DEVICES (if so equipped)

Connecting auxiliary devices

Connect an AUX device to the AUX input jack.

AUX input jack location:

"USB (Universal Serial Bus) connection ports and AUX (auxiliary) input jack" (page 2-7)

The AUX input jack accepts any standard analog audio input such as from a portable cassette player, CD player or MP3 player.



INFO:

Insert a 1/8 in (3.5 mm) stereo mini plug in the audio input jack. If a cable with a mono plug is used, the audio output may not function normally.

AUX operation

Activation and playing:

Turn on an AUX device.

Connect an AUX cable to the AUX device and the AUX input jack. Select AUX mode from the audio source menu screen or by pushing <DISC-AUX>.

3. Audio system

☞ "Selecting audio source" (page 3-13)

☞ "Audio main buttons" (page 3-11)

How to view AUX screen

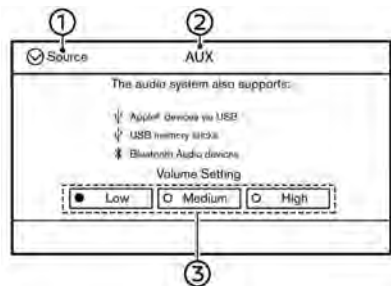

① [Source]:

Touch to switch to the source menu screen.

☞ "Selecting audio source" (page 3-13)

② Audio source indicator:

Indicates that the AUX source is currently playing.

③ Volume Setting keys:

Touch one of the keys to select the sound output gain from [Low], [Medium] and [High].

SMARTPHONE AUDIO

You can also listen to music from your compatible smartphone using Apple CarPlay® or Android Auto.

☞ "Apple CarPlay®" (page 5-18)

☞ "Android Auto™" (page 5-22)

Connecting smartphone

Connect the iPhone® or Android phone to the USB connection port.

☞ "USB (Universal Serial Bus) connection ports and AUX (auxiliary) input jack" (page 2-7)

☞ "USB connection ports" (page 2-8)



INFO:

Depending on the models, specifications and software versions, Apple CarPlay® can also be connected to the vehicle wirelessly.

☞ "Connecting wirelessly" (page 5-19)

Smartphone audio operation

1. Connect the iPhone® or Android phone to the USB connection port and activate Apple CarPlay® or Android Auto.
2. Push <AUDIO>.
3. Touch [Source].

4. Touch [Apple CarPlay] or [Android Auto] in the audio source menu screen, and the smartphone audio starts activating.

☞ "Selecting audio source" (page 3-13)



INFO:

- The smartphone audio can also be played by pushing <MEDIA>/<DISC-AUX>.☞ "Audio main buttons" (page 3-11)
- If Apple CarPlay® or Android Auto is active on the upper display, the smartphone audio can also be started by operating Apple CarPlay® or Android Auto screen.
- Audio operation is unavailable on the lower display. To operate the smartphone audio, operate Apple CarPlay® or Android Auto screen.☞ "Apple CarPlay®" (page 5-18)☞ "Android Auto™" (page 5-22)

AUDIO SETTINGS

1. Push <MENU> and touch [Settings].
2. Touch [Sound].

Available setting items may vary depending on models, specifications and software versions.

Available setting items

Setting items	Action
[Bass]	Adjust the speaker tone quality and sound balance by touching [-]/[+], [L]/[R] or [R]/[F].
[Mid]	
[Treble]	
[Balance]	
[Fade]	
[Bass enhancer]	When this item is turned on, the system enhances bass sound.
[Speed Sensitive Volume]	Automatically adjusts the volume depending on the vehicle speed. Touch [-]/[+] to change the sensitivity level.
[Bose AudioPilot]	Adjusts the volume and sound quality depending on the changes of the vehicle speed and the noise picked up by the microphone. It compensates for noise for different road surface conditions and open windows. Turn on the item to activate Bose AudioPilot.
[Bose Centerpoint]	When this item is turned on, surround sound playback is generated from a traditional stereo recording. Turn on the item to activate Bose Centerpoint and to change its effect level with [Surround Volume].
[Surround Volume]	Touch [+]/[-] to adjust the Surround Effect level if Bose Centerpoint is turned on.
[Driver's Audio Stage]	When this item is turned on, a better sound will be provided to the driver's position. The driver can enjoy a more crisp and clear sound that is specialized for the driver's seat position. The prominence of the effect of this feature depends on the type of music that is played. For some music, it may be difficult to recognize the effect of the feature.

3. Audio system

CD/USB MEMORY DEVICE CARE AND CLEANING

CD (if so equipped)

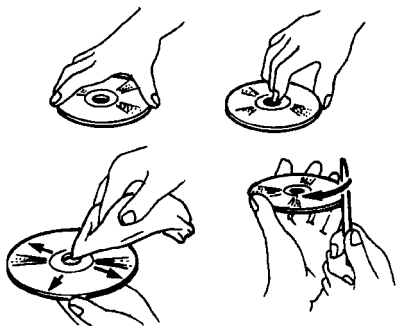

- Handle a CD by its edges. Never touch the surface of the disc. Do not bend the disc.
- Always place the discs in the storage case when they are not being used.
- To clean a disc, wipe the surface from the center to the outer edge using a clean, soft cloth. Do not wipe the disc using a circular motion.

Do not use a conventional record cleaner

or alcohol intended for industrial use.

- A new disc may be rough on the inner and outer edges. Remove the rough edges by rubbing the inner and outer edges with the side of a pen or pencil as illustrated.

USB MEMORY DEVICE

- Never touch the terminal portion of the USB memory device.
- Do not place heavy objects on the USB memory device.
- Do not store the USB memory device in highly humid locations.
- Do not expose the USB memory device to direct sunlight.
- Do not spill any liquids on the USB memory device.

Refer to the USB memory device Owner's Manual for the details.

4 Hands-Free Phone

Bluetooth® Hands-Free Phone System	4-2
Phone screen	4-3
Indicators	4-4

Phone	4-4
Hands-free text messaging assistant	4-7
Phone and text message settings	4-11



4. Hands-Free Phone

BLUETOOTH® HANDS-FREE PHONE SYSTEM



WARNING

- Use a phone after stopping your vehicle in a safe location. If you have to use a phone while driving, exercise extreme caution at all times so full attention may be given to vehicle operation.
- If you find yourself unable to devote full attention to vehicle operation while talking on the phone, pull off the road to a safe location and stop your vehicle before doing so.



CAUTION

To avoid draining the vehicle battery, use a phone only after starting the engine.

Your vehicle is equipped with Bluetooth® Hands-Free Phone System. If you are an owner of a compatible Bluetooth® enabled cellular phone, you can set up the wireless connection between your cellular phone and the in-vehicle phone module. With Blue-

tooth® wireless technology, you can make or receive a telephone call with your cellular phone in your pocket.

Once a cellular phone is connected to the in-vehicle phone module, the procedures for connecting the phone does not need to be performed again. Your phone will automatically re-connect to the in-vehicle phone module when the ignition switch is placed in the ACC or ON position with the selected cellular phone turned on and carried in the vehicle.

You can register up to 6 different Bluetooth® devices in the in-vehicle phone module. However, you can talk on only one cellular phone at a time.

The Voice Recognition System supports phone and text message commands, so dialing a phone number using your voice is possible.

 "7. Voice recognition"

Before using the Bluetooth® Hands-Free Phone System, refer to the following notes.

- Wireless LAN (Wi-Fi) and the Bluetooth® functions share the same frequency band (2.4 GHz). Using the Bluetooth® and the wireless LAN functions at the same time may slow down or

disconnect the communication and cause undesired noise. It is recommended that you turn off the wireless LAN (Wi-Fi) when using the Bluetooth® functions.

- Set up the wireless connection between a compatible cellular phone and the in-vehicle phone module before using the Bluetooth® Hands-Free Phone System.
- Some Bluetooth® enabled cellular phones may not be recognized by the in-vehicle phone module. Visit the website below for a recommended phone list. www.infiniti.com/bluetooth/
- When Apple CarPlay® or Android Auto is active, Apple CarPlay® or Android Auto will take the place of your Bluetooth® Hands-Free Phone functionality.
- You will not be able to use a hands-free phone under the following conditions:
 - Your vehicle is outside of the telephone service area.
 - Your vehicle is in an area where it is difficult to receive radio waves; such as in a tunnel, in an underground parking garage, behind a tall building or in a mountainous area.

- Your cellular phone is locked in order to prevent dialing.
- If Apple CarPlay® or Android Auto is active, the Bluetooth® Hands-Free Phone cannot be used.
- When the radio wave condition is not ideal or ambient sound is too loud, it may be difficult to hear the other person's voice during a call.
- Immediately after the ignition switch is placed in the ACC or ON position, it may not be possible to receive a call for a short period of time.
- Do not place the cellular phone in an area surrounded by metal or far away from the in-vehicle phone module to prevent tone quality degradation and wireless connection disruption.
- While a cellular phone is connected through the Bluetooth® wireless connection, the battery power of the cellular phone may discharge quicker than usual.
- Visit the website below for troubleshooting help if the Bluetooth® Hands-Free Phone System seems to be malfunctioning.
www.infiniti.com/bluetooth/
- Some cellular phones or other devices may cause interference or a buzzing noise to come from the audio system speakers. Storing the device in a different location may reduce or eliminate the noise.
- Refer to the cellular phone Owner's Manual regarding the telephone pairing procedure specific to your phone, battery charging, cellular phone antenna, etc.
- The antenna or battery display on the monitor may not coincide with the antenna or battery display of some cellular phones.
- If reception between callers is unclear, adjusting the incoming or outgoing call volume may improve the clarity.
 "Volume and Beeps settings"
(page 2-31)
- The microphone is located near the map light.
- To improve call quality, the microphone is optimized to recognize the driver's voice. Speech from vehicle passengers may not be captured by the Bluetooth® Hands-Free Phone System.



- Keep the interior of the vehicle as quiet as possible to hear the caller's voice clearly as well as to minimize echo.
Reduce background noise as much as possible by closing windows and pointing HVAC vents away from the ceiling.

PHONE SCREEN

The phone screen can be displayed by on both the upper display and the lower display.

- Push <  > on the steering wheel to display the phone screen on the upper display.
- Push <MENU> and touch [Phone] to display the phone screen on the lower display.

Available items

Menu item	Action
[Quick Dial]	Displays the Quick Dial screen.  "Making a call" (page 4-5)
[Phonebook]	Displays the phonebook screen.  "Making a call" (page 4-5)

4. Hands-Free Phone

[Call History]	Displays the call history screen. ☞ "Making a call" (page 4-5)
[Dial Number]	Displays the phone number entry screen. ☞ "Making a call" (page 4-5)
[Text Message]	Displays the received message list screen. ☞ "Displaying received message list" (page 4-8)
[Connections]	Displays the Connections screen. ☞ "Setting devices" (page 2-27)
[Volume]	Displays the volume adjustment screen. ☞ "Volume settings" (page 4-13)



INFO:

Depending on the connected device, some functions cannot be used.

INDICATORS

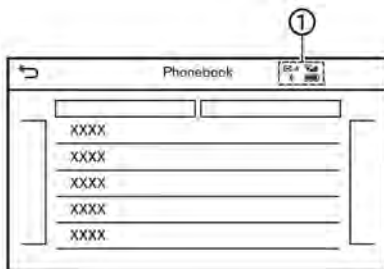

When a cellular phone is connected through the Bluetooth® wireless connection, indicators ① for phone and text messaging are displayed on the upper display.

✉ 1	Indicates the number of unread received messages.
📶	Indicates that Bluetooth® device (s) are connected.
📶	Indicates the strength of the signal the Bluetooth® device is receiving.
🔋	Indicates the amount of remaining Bluetooth® device battery.

PHONE

Connecting Bluetooth® Hands-Free Phone

A cellular phone device must be connected to the Bluetooth® Hands-Free Phone System before operation. Up to 6 Bluetooth® devices can be connected to the system.

☞ "Setting devices" (page 2-27)

Phone selection

Follow the instructions below to select a connected device for use with the Bluetooth® Hands-Free Phone System:

1. Push <MENU> and touch [Connections].
2. Touch [Devices]. A list of the connected cellular phones is displayed.
3. Touch one of the connected cellular phones from the list.

When the connection is successful, "Connected" is displayed under the device name.

If [📶] is displayed in gray, touch [📶].

INFO:

To select a phone, the Bluetooth® of the cellular phone needs to be turned on.

Making a call

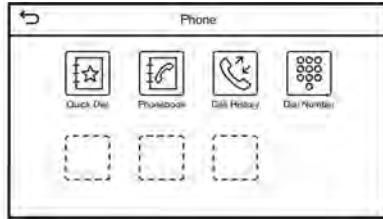



1. Push **<MENU>** and touch [Phone].
2. Select one of the following methods to make a call.

Available items:

- [Quick Dial]:
Select a telephone number registered as a Quick Dial number.
 "Quick Dial" (page 4-13)
- [Phonebook]:
Select a person and the phone number you wish to call from the phonebook.
Depending on the device, the phonebook will be downloaded from the cellular phone automatically when it is connected. If the automatic download

does not take place, the telephone number must be transferred to the Hands-Free Phone System from the cellular phone prior to using this method.

 "Phone settings" (page 4-11)

- [Call History]:
Select a telephone number from recent incoming, outgoing or missed calls.
- [Dial Number]:
Enter the phone number manually using the keypad displayed on the screen.
 "How to input letters and numbers" (page 2-11)

INFO:

Either of the connected phone devices can be selected for dialing operation when [Allow 2 Phones Simultaneously] is turned on.

 "Bluetooth® settings" (page 2-28)

3. Dialing will start and the screen will change to the call in progress screen.

Receiving a call

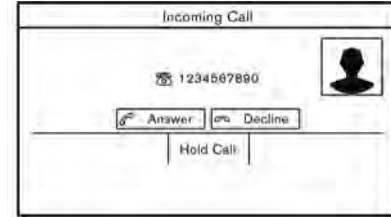

When you receive a phone call, the upper display switches to the Incoming Call screen and the ringtone is played through the vehicle's audio system.

Taking a call:

To answer the call, take one of the following actions.

- Push **<  >** on the steering wheel.
- Touch [Answer].

Rejecting a call:

To reject the call, take one of the following actions.

- Push and hold **<  >** on the steering wheel.
- Touch [Decline].

4. Hands-Free Phone

Holding a call:

To hold the call, touch [Hold Call].



INFO:

If [Allow 2 Phones Simultaneously] is turned on, two hands-free phone devices can be connected at the same time. If one of the connected devices receives an incoming call while the other device is already online, a pop-up message will appear to inform that answering the call will hang up the line of the other connected device. Touch [Answer] to answer the call and hang up the line on the other device. Touch [Decline] to continue the conversation on the other device.

☞ "Bluetooth® settings" (page 2-28)

During a call

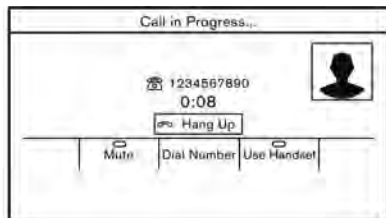

The Call in Progress screen will appear during a call.

To hang up the phone, touch [Hang up].

Operations during a call:

There are some options available other than hanging up a call or answering/rejecting incoming calls.

Touch one of the following displayed keys on the screen to take action.

Available item	Action
[Mute]	When muted, your voice will not be heard by the person on the other end of the line.
[Dial Number]	Using the touch-tone, send digits to the connected party for using services such as voicemail.
[Use Handset]	Transfer the call to the cellular phone.
[Switch Call]*	Answer another incoming call. The person you are talking to will be placed on hold. Push once more to speak to the person on hold again.

*: Available when a call is received while on the line with another person. The availability of this function depends on the cellular

phone.



INFO:

- To adjust the person's voice to be louder or quieter, push <- +> on the steering wheel or turn <VOL/> while talking on the phone.
- **Models with navigation system:**
If <MAP/VOICE> on the INFINITI controller is pushed during a call, map or menu screen is displayed.
- **Models without navigation system:**
If <DISP> on the INFINITI controller is pushed during a call, the clock is displayed.

Call from a second person:

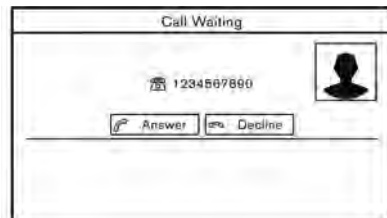

When another phone call is received during a call, the Call Waiting screen will appear.

Answering call from a second person:

To answer the call from the second person and place the first caller on hold, take one of the following actions.

- Push <  > on the steering wheel.
- Touch [Answer].

Rejecting call from a second person:

To reject a call from the second person and continue the conversation with the first caller, touch [Decline].

During a call with a second person:

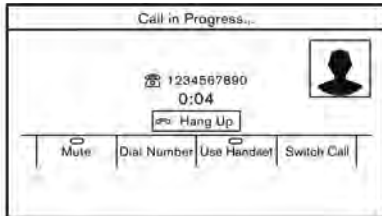

To hang up the phone and return to the conversation with the first caller, touch [Hang up].

To switch between two calls on line, touch [Switch Call].

HANDS-FREE TEXT MESSAGING ASSISTANT

WARNING

- Use the text messaging feature after parking your vehicle in a safe location. If you have to use the feature while driving, exercise extreme caution at all times so full attention may be given to vehicle operation.
- Laws in some jurisdictions may restrict the use of "Text-to-Speech". Check local regulations before using this feature.
- Laws in some jurisdictions may restrict the use of some of the applications and features, such as social networking and texting. Check local regulations for any requirements.
- If you are unable to devote full attention to vehicle operation while using the text messaging feature, pull off the road to a safe location and stop your vehicle.

CAUTION

This feature is disabled if the connected device does not support it. Refer to the cellular phone Owner's Manual for details and instructions.

The system allows for the sending and receiving of text messages through the vehicle interface.

The availability of the text message function may vary depending on the cellular phone.

Receiving a message

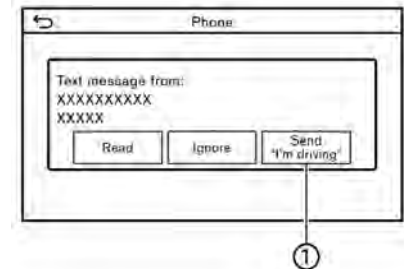

When the cellular phone connected to the vehicle receives a text message, a notification will appear on the upper display and on the vehicle information display with a tone.

4. Hands-Free Phone

To check the message, touch [Read]. Touch [Ignore] to save the message to be checked later.



If you want to reply to the message, touch the reply key  (if so equipped).

The reply message can be selected.

 "Phone settings" (page 4-11)



INFO:

- Replying to text messages may not be supported by all phones. Please check your phone's owner's manual for details.
- Depending on the cellular phone, the notification display setting may need to be activated on the cellular phone.
- Whether to read or ignore the message can be selected operating the switch on the steering wheel. Push <  > to read the message. Push and hold <  > to ignore the message.

Displaying received message list

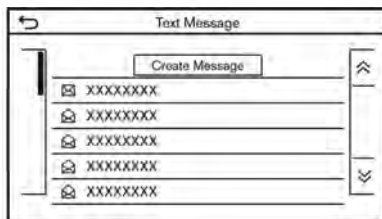

1. Push <MENU> and touch [Phone].
2. Touch [Text Message].
3. Touch an item on the list to read or reply to the message.



INFO:

- Up to 100 messages can be stored in the message list.
- Either of the connected phone devices can be selected for text message viewing operation when [Allow 2 Phones Simultaneously] is turned on.
 "Bluetooth® settings" (page 2-28)

Received message screen

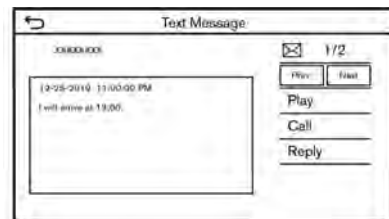

Touching [Read] on the new message notification screen or selecting a message from the message list will show the details of the received message on the lower display.

Available actions:

- [Prev]:
Touch to read the previous message.
- [Next]:
Touch to read the next message.
- [Play]/[Stop]:
Touch [Play] to have the Hands-Free Phone System read out the received message. Touch [Stop] to stop reading.
- [Call]:
If the sender of the message is registered in the Phonebook, touch this icon to make a call to the sender.

- [Reply]:
A reply message can be selected from the template.
☞ "Sending a text message"
(page 4-9)

INFO:

- Available keys may vary depending on the situations, the cellular phone and the software versions.
- If the sender's name and phone number are registered in the Phonebook, the name of the sender is displayed when a message is received.
- To adjust the message reading voice volume, push <- 🔊 +> on the steering wheel or turn <VOL/ 🔊 >.

Sending a text message

This function may not be supported depending on the cellular phone.

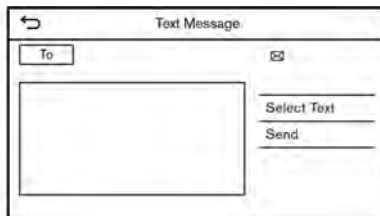

1. Push <MENU> and touch [Phone].
2. Touch [Text Message].
3. Touch [Create Message].

INFO:

Either of the connected phone devices can be selected for text message sending operation when [Allow 2 Phones Simultaneously] is turned on.

☞ "Bluetooth® settings" (page 2-28)

4. Hands-Free Phone

The following items are available.

Available item		Action
[To]	[Enter Number by Keypad]	Enter the phone number of the recipient using the keypad. Touch [OK] to confirm.
	[Quick Dial]	Select a recipient from the Quick Dial list.
	[Phonebook]	Select a recipient from the Phonebook.
	[Call History]	Select a recipient/phone number from call history.
[Select Text]	[Fixed]	Touch to display a list of fixed text messages.
	[Customized]	Touch to display a list of custom text message templates. Custom text can be created or edited from the setting menu.  "Phone and text message settings" (page 4-11)
[Send]		Touch to send the message.

PHONE AND TEXT MESSAGE SETTINGS

Phone settings

Bluetooth® Hands-Free Phone System settings can be changed according to the user's preference.

1. Push <MENU> and touch [Settings].
2. Touch [Phone].

Available setting items may vary depending on models, specifications and software versions.

Available setting items

Setting item		Action
[Connections]		Displays the Connections screen. Phone connection, selection, deletion and other features are available. ☞ "Connections settings" (page 2-27)
[Quick Dial]	[Edit]	Entries in the Quick Dial can be edited. Touch [Add New] to register a new entry. ☞ "Quick Dial" (page 4-13)
	[Delete All]	Deletes all of the phone numbers in the Quick Dial.
[Phonebook]	[Download Entire Phonebook]	All of the phone numbers that are stored in a phonebook of a cellular phone that is connected to the vehicle are downloaded at once.
	[Auto Downloaded]	Turns on/off automatic downloading of the phonebook from the connected cellular phone.
	[Sort Phonebook by]	Changes the sorted order of contacts in the phonebook.

4. Hands-Free Phone

[Text Message]	[Text Message]	Turns the text messaging function on/off.
	[Text Message Ringtone]	Turns the incoming message sound on/off.
	[Signature]	Turns the signature setting for the outgoing text message on/off.
	[Auto Reply]	Turns on/off the automatic text message reply function.
	[Auto Reply Text Message]	Selects the text message to be used for the automatic reply function.
	[Edit Custom Text]	Creates or edits a customized text message reply.
[Notifications]	[Driver Only]	When this item is turned on, incoming call notification is displayed only in the vehicle information display.
	[Vehicle Ringtone]	Turns the vehicle ringtone on/off.
[Automatic Hold]		When this item turns on, an incoming phone call will be put on hold automatically.



INFO:

- If [Allow 2 Phones Simultaneously] is turned on, available phone names are displayed on the Phone settings screen. You can select the phone you wish to apply the settings. You can also display the Connections screen by touching [☰].
☞ "Connections settings" (page 2-27)
- [Driver Only] is unavailable while Apple CarPlay® or Android Auto is active.

Volume settings

Volume settings can be adjusted.

1. Push **<MENU>** and touch [Phone].
2. Touch [Volume].

The following volume setting items are available.

Setting items	Action
[Ringtone]	Adjusts the volume level of the ringtone of incoming calls.
[Outgoing Call]	Adjusts the volume level of the outgoing calls.



INFO:

The phone volume setting menus can also be accessed from the Settings screen.

"System settings" (page 2-21)

Quick Dial

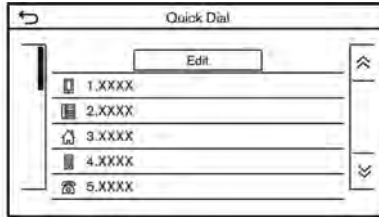

Up to 20 Quick Dial entries can be registered.

Quick Dial entries can be used to quickly make a call or send text messages.

Registration:

1. Push **<MENU>** and touch [Phone].
2. Touch [Quick Dial].
3. Touch [Edit].
4. Touch [Add New] to register a phone number to the Quick Dial list.
5. Select a method for registration.

Available methods:

- [Copy from Call History]:
A phone number can be selected from [All], [Incoming], [Outgoing], or [Missed] call history lists.

- [Copy from Phonebook]:
A phone number can be selected from the Phonebook.
- [Enter Number by Keypad]:
A phone number can be entered manually using keypad.



INFO:

Available methods may vary depending on cellular phone support.

6. When a phone number has been selected, the registration screen is displayed. Enter the phone number and edit the entry information as necessary.
7. Touch [OK] to save the entry.



INFO:

- Quick Dial entries can also be registered by pushing **<MENU>** and touching [Settings], and then touch [Phone].
 "Phone settings" (page 4-11)
- Either of the connected phone devices can be selected for dialing operation when [Allow 2 Phones Simultaneously] is turned on.
 "Bluetooth® settings"

4. Hands-Free Phone

(page 2-28)

- Touch [Delete] to delete the voice tag.

Voice Tag:

A voice tag can be recorded for each of the registered Quick Dial numbers and can be used to dial the number by speaking it.

Quick Dial	
OK	
Entry Number	0
Name	XXXX
Number	1
Type	M
Relationship / Voice Tag	XXXXXX

Example

On the Quick Dial registration screen, select [Relationship / Voice Tag].

- Select a preferred relationship from the list.
- Touch [Customize] and touch [Record] to register your original voice tag.

INFO:

- Touch [Play] to play the recorded voice tag.

5 Information and vehicle settings

Information menu	5-2	Android Auto™	5-22
Updating system software (if so equipped)	5-5	Compatibility	5-22
INFINITI InTouch™ Services (if so equipped)	5-7	Initial Android Auto settings	5-23
Subscription to INFINITI InTouch™ Services	5-7	Android Auto operation	5-23
Important information regarding access to		Android Auto settings	5-25
INFINITI InTouch™ Services	5-7	Android Auto system limitations	5-26
INFINITI InTouch™ Services features	5-8	Siri® Eyes Free	5-26
INFINITI InTouch™ Services Menus	5-11	General information	5-26
INFINITI InTouch™ Services settings	5-14	Requirements	5-26
SiriusXM® Travel Link (if so equipped)	5-15	Siri® Eyes Free activation	5-26
Viewing SiriusXM® Travel Link	5-15	Operating Siri® Eyes Free	5-27
Using SiriusXM® Travel Link	5-15	TomTom Weather information	5-27
Apple CarPlay®	5-18	Fully customizable digital environment	5-29
Compatibility	5-18	User registration	5-29
Connecting iPhone®	5-18	Editing user information	5-29
Apple CarPlay® operation	5-20	Setting INFINITI InTuition feature	5-31
Apple CarPlay® settings	5-21	Driver Assistance settings	5-32
Apple CarPlay® system limitations	5-22	INFINITI Drive Mode Selector settings	5-34

5. Information and vehicle settings









INFORMATION MENU

The information screen sets or displays various information that is helpful for using the vehicle.





Push **<MENU>** and then touch [Information] to display the Information menu.

Available items may vary depending on models, specifications and software versions.

Items displayed on the screen may not function depending on various conditions.

Menu item	Action
[InTouch Services]	Displays the INFINITI InTouch™ Services menu screen.  "INFINITI InTouch™ Services" (page 5-7)
[SXM Weather]	Displays the SiriusXM® Weather screen.  "Using SiriusXM® Travel Link" (page 5-15)
[SXM Traffic]/[Premium Traffic]	Displays the Traffic Information screen.  "Viewing traffic information" (page 6-40)
[SXM Sports Scores]	Displays the SiriusXM® Sports screen.  "Using SiriusXM® Travel Link" (page 5-15)
[SXM Stocks]	Displays the SiriusXM® Stocks screen.  "Using SiriusXM® Travel Link" (page 5-15)
[SXM Fuel Prices]	Displays the SiriusXM® Fuel Prices screen.  "Using SiriusXM® Travel Link" (page 5-15)
[SXM Parking]	Displays the SiriusXM® Parking screen.  "Using SiriusXM® Travel Link" (page 5-15)
[SXM Movie Listings]	Displays the SiriusXM® Movie Listings screen.  "Using SiriusXM® Travel Link" (page 5-15)
[Where Am I?]	The name and distance of the next/previous street, and other information that indicates the current vehicle location are displayed.

5. Information and vehicle settings

Menu item		Action
[System Information]	[Version Information]	Displays the information of the Software Version, etc.
	[Software Update]	The system software can be updated.  "Updating system software" (page 5-5)
	[Map Update]	The map data can be updated.  "How to update map data" (page 6-61)
	[SXM Information]	Displays the SiriusXM® information. The signal quality, subscription status and SiriusXM® radio ID, etc. are displayed.
	[License Information]	Displays the Open Source Software (OSS) licenses information.
[GPS Position]		Displays GPS information, such as number of satellites, latitude/longitude, and approximate altitude, etc.
[Vehicle Data Transmission]		When [OK] is touched, data transmission to INFINITI is enabled. Touching [Decline] disables the INFINITI InTouch™ Services, Premium Traffic, Online Search, etc.
[Apps]	[Apple CarPlay]	Displays the Apple CarPlay® screen.  "Apple CarPlay®" (page 5-18)
	[Android Auto]	Displays the Android Auto screen.  "Android Auto™" (page 5-22)

5. Information and vehicle settings

Menu item		Action
[Vehicle]	[Fuel Economy]	Display the Fuel Economy screen. The current and average fuel economy, the distance to empty can be confirmed.
	[History]	Display Fuel Economy history screen. The Fuel Economy history screen can be scrolled.
	[Reset]	Reset the average Fuel Economy. The average for the Reset-to-Reset period is stored as a fuel economy history. When reset average Fuel Economy on the screen, the average fuel consumption on the trip computer is also reset at the same time.
[TomTom Weather]		Displays the TomTom Weather information.  "TomTom Weather information" (page 5-27)



INFO:

A SiriusXM® Travel Link (if so equipped) or SiriusXM Traffic™ (if so equipped) subscription is necessary to receive SiriusXM® information services.

UPDATING SYSTEM SOFTWARE (if so equipped)



WARNING

TO AVOID RISK OF DEATH OR SERIOUS PERSONAL INJURY WHEN UPDATING THE SYSTEM SOFTWARE:

If you choose to park the vehicle within range of a Wi-Fi connection (if so equipped), park the vehicle in a secure, safe well-ventilated location that is open to the air. During the update process, if you choose to park your vehicle, it should be kept in a well-ventilated area to avoid exposure to carbon monoxide. Do not breathe exhaust gases; they contain colorless and odorless carbon monoxide. Carbon monoxide is dangerous. It can cause unconsciousness or death.

1. Apply the parking brake.
2. Remain with the vehicle while the update is in process.
3. Do not allow children, pets or people who may need assistance to remain in the vehicle while the software is updating.



NOTE:

The vehicle is not required to be parked during the software update process. If the vehicle disconnects from the Wi-Fi connection (if so equipped), it will resume when the vehicle reconnects to a known Wi-Fi connection.



INFO:

- The system prioritizes Wi-Fi connection over TCU (Telematics Control Unit) when Wi-Fi network connection is available.
- You will be charged separately when the network communication is made via smartphones.
- The download data size of software updates can vary between 80 MB to 300 MB. If you use your smartphone as a Wi-Fi connection, you may incur data charges from your phone carrier. Please connect to a secure WPA2 Wi-Fi network to avoid potential phone carrier data charges.

How to update from the pop-up screen

When both of the following conditions are met, the system informs the driver with a pop-up on the screen when system software update is available.

- [Auto] is selected under [Update Method].
 - "How to update from the system menu" (page 5-6)
 - Wi-Fi or TCU (Telematics Control Unit) network connection is available.
 - "Wi-Fi Setting" (page 2-29)
 - "INFINITI InTouch™ Services settings" (page 5-14)
1. When the pop-up appears and prompts the driver to perform the system software update, operate the system according to the guides shown on the screen to download the updates. Another pop-up will appear when downloading is complete.
 2. After the system software update is complete, place the ignition switch in the OFF position and leave the system for 20 minutes without operating the switches on the control panel and the

5. Information and vehicle settings

steering wheel. Place the ignition switch in the ON position and the updated software will be available.

INFO:

- The update may not be reflected if the ignition switch is placed back in the ON position before the 20 minute period has passed.
- In some cases, updates can only be performed via TCU (Telematics Control Unit).
- In some cases, the pop-up message may appear even when [Manual] is selected under [Update Method].

How to update from the system menu



WARNING

To operate the system for software update, first park the vehicle in a safe location.

System software updates can be downloaded manually via Wi-Fi or TCU (Telematics Control Unit) from the system menu.

1. Connect to network via Wi-Fi to perform the software update via Wi-Fi connection.
 "Wi-Fi Setting" (page 2-29)
2. Push <MENU>.
3. Touch [Information] and then touch [System Information].
4. Touch [Software Update].
5. Touch [Start Software Update].

INFO:

When [Update Method] is set to [Auto], a notification is made in case that software can be updated.

6. Touch [Download] to start downloading and updating the system software.
7. After the system software update is complete, place the ignition switch in the OFF position and leave the system for 20 minutes without operating the switches on the control panel and the steering wheel. Place the ignition switch in the ON position and the updated software will be available.



INFO:

- The update may not be reflected if the ignition switch is placed back in the ON position before the 20-minute period has passed.
- If updating software is unnecessary, touch [OK] to return to the previous screen.
- [Save Version Information to USB Device] is not available on this system.

INFINITI INTOUCH™ SERVICES (if so equipped)

SUBSCRIPTION TO INFINITI INTOUCH™ SERVICES

Subscription is required to use the INFINITI InTouch™ Services. For the details about the subscription, visit the INFINITI Owner's Portal Website or contact an INFINITI retailer.

IMPORTANT INFORMATION REGARDING ACCESS TO INFINITI INTOUCH™ SERVICES

Feature availability is dependent on vehicle model, trim level, packaging and options. Trial included with vehicle purchase. Compatible connected device may be required and feature availability may be dependent on device's capability. Refer to connected device's owner's manual for details. Late availability for some features.

Driving is serious business and requires your full attention. Only use features and connected devices when safe and legal to do so. Some features, including automatic crash notification and SOS, are dependent upon the telematics device being in operative condition, its ability to connect to a wireless

network, compatible wireless network availability, navigation map data and GPS satellite signal receptions, the absence of which can limit or prevent the ability to reach Customer Care or receive support. GPS mapping may not be detailed in all areas or reflect current road status. Never program GPS while driving. Only use Remote Engine Start and Remote Horn features in accordance with any laws, rules or ordinances in effect in your vehicle's location.

Some services and features are provided by and dependent on third party service providers and not INFINITI. Should such service providers terminate or restrict service or features, service or features may be suspended or terminated without notice or with no liability to INFINITI or its partners or agents. Services and features may require compatible cellular network provided by independent companies not within INFINITI or its partners' or agents' control. Cellular network signal strength may vary and may not be available in all areas or at all times. Services and features may not function if cellular network is unavailable, restricted, or terminated. INFINITI and its partners or agents are not responsible for associated costs or other third-party changes that may

be required for continued operation due to cellular network unavailability, restriction, or termination (including equipment replacements/upgrades, if available, or roaming charges on alternative networks). Technology is evolving, and changes by independent companies are not within INFINITI's or its partners' or agents' control.

Enrollment, owner consent, personal identification number (PIN), and subscription agreement may be required to receive full suite of features and services. Trial periods (if applicable) begin on the date of vehicle purchase or lease of a new INFINITI. Trial periods and feature availability may be subject to change at any time and may be subject to early termination without notice. Required subscriptions may be sold separately for each available feature or service after trial period ends, and may continue until you call service provider to cancel. Installation costs, one-time activation fee, other fees and taxes may apply. Fees and programming subject to change. Feature may be subject to age restrictions in some areas. Subscriptions governed by service provider's subscription agreement, terms and conditions and privacy statements available at service provider's website. Text rates

5. Information and vehicle settings

or data usage may apply. INFINITI InTouch™ with WiFi terms and conditions of subscriber agreement apply. Included with vehicle purchase 1 GB or 30 Day Trial on equipped new INFINITI vehicles. If your Vehicle is outside the scope of the initial roadside assistance plan included with the purchase of your Vehicle that applies for a period of 48 months, without regard to mileage from the date the Vehicle is delivered to the first retail buyer or otherwise put into use, whichever is earlier you will be responsible to the Service Provider for any additional charges incurred by receiving services through that roadside assistance Service Provider.

The INFINITI names, logos and slogans are trademarks owned by or licensed to Nissan Motor Co. Ltd. or its North American subsidiaries. Other trademarks and trade names are those of their respective owners.

For important safety information, system limitations, and additional operating and feature information, see dealer, owner's manual, or <https://www.infiniti.com/intouch/legal.html>.

INFINITI INTOUCH™ SERVICES FEATURES

INFINITI InTouch™ Services provides various types of information and services by connecting your vehicle to the INFINITI InTouch™ Services Data Center and INFINITI InTouch™ Services Response Center using the TCU (Telematics Control Unit) installed in your vehicle.

If equipped, your vehicle may include INFINITI InTouch™ connected features and services such as emergency SOS calling, Automatic Collision Notification, Wi-Fi, Remote Services, Navigation, Bluetooth® and more. For complete information about your INFINITI InTouch™ features and services, please visit www.infiniti.com/intouch. For frequently asked questions, please visit www.infiniti.com/intouch/faq.



WARNING

- **Please note that the Automatic Collision Notification service and Emergency Call function cannot be used in the following conditions:**
 - Emergency functions and services will not be available without a paid subscription to INFINITI InTouch™

Services.

- The INFINITI InTouch™ Services network system is disabled.
- The vehicle moves outside the service area where the TCU (Telematics Control Unit) is connected to the system.
- The vehicle is outside the area where the cellular network service is receivable.
- The vehicle is in a location with poor signal reception such as tunnels, underground parking garages, behind buildings or in mountainous areas.
- The line is busy.
- The TCU (Telematics Control Unit) or other systems of your vehicle are not working properly.
- It may not be possible to make an emergency call depending on the severity of a collision and/or emergency.
- Radio waves could adversely affect electric medical equipment. Individuals who use a pacemaker should

contact the device manufacturer regarding any possible effects before using the system.

- **The TCU (Telematics Control Unit) antenna is installed inside the upper central part of the instrument panel. An occupant should not get any closer to the antenna than specified by the pacemaker manufacturer. The radio waves from the TCU antenna may adversely affect the operation of the pacemaker while using the INFINITI InTouch™ Services.**



INFO:

- INFINITI InTouch™ Services features are dependent upon subscription enrollment and the telematics device being in operative condition, cellular connectivity, navigation map data and GPS satellite signal reception. Terms and conditions of the INFINITI InTouch™ Services Subscription Agreement apply.
- Enrollment is required in order to use INFINITI InTouch™ Services. The services that can be received vary depending on the plan in which you are enrolled.

- All services are complimentary for the trial period.
- After the trial period, use of the service will no longer be complimentary.
- Laws in some jurisdictions may restrict the use of "Text-to-Speech." Check local regulations before using this feature.

If equipped, your vehicle may include INFINITI InTouch™ connected features and services such as emergency SOS calling, Automatic Collision Notification, Wi-Fi, Remote Services, Navigation, Bluetooth® and more.

INFINITI InTouch™ Services may be updated. The latest detailed information is available on the following websites or from the support line.

INFINITI InTouch™ Services website:

For U.S.

www.infiniti.com/intouch

For Canada

<https://www.infiniti.ca/intouch> (English)

<https://fr.infiniti.ca/intouch> (French)

INFINITI InTouch™ Services support line:

1-855-444-7244

- **Automatic Collision Notification (if so equipped):**

The TCU (Telematics Control Unit) generates a signal automatically to the INFINITI InTouch™ Services Response Center in the case of an accident severe enough to trigger one of the vehicle's air bags. Upon the signal, a Response Specialist receives the vehicle location and customer information and notifies the proper authorities in accordance with established policies and procedures.

- **Emergency Call (if so equipped):**

The Emergency Call feature provides emergency assistance by connecting to a Response Specialist. In the event of an emergency, push the in-vehicle E-Call (SOS) button to use this feature. The Response Specialist provides various assistance depending on the situation.

For details of the E-Call (SOS) button operation, refer to the vehicle Owner's Manual.

- **Connection to Roadside Assistance (if so equipped):**

Roadside Assistance allows you to receive assistance from the Roadside Re-

5. Information and vehicle settings

sponse Specialist for a non-emergency incident that requires a towing or third-party response service. The service is accessed by pushing the in-vehicle E-Call (SOS) button. Roadside Assistance may also be used in conjunction with the Emergency Assistance service, if warranted.

For details of the E-Call (SOS) button operation, refer to the vehicle Owner's Manual.

Notice to Bluetooth® Hands-Free Phone users

The Bluetooth® Hands-Free Phone System will be disabled and not be able to take phone calls while the vehicle is connected to the INFINITI InTouch™ Services Response Specialists or the emergency support staff at the INFINITI Response Center.

This is to avoid various services by INFINITI InTouch™ Services Response Specialists (such as route guidance) and INFINITI InTouch™ Services emergency support staff being interrupted by incoming calls. Incoming phone calls received while the vehicle is connected to the Service Center will not be listed in the call history of the Bluetooth® Hands-Free Phone System.

However those incoming calls may be listed in the call history of your mobile phone, depending on its capabilities. After disconnecting communication with the INFINITI InTouch™ Services Response Specialist or INFINITI InTouch™ Services emergency support staff, check the incoming call history on your mobile phone when it is safe to do so.

Service application

A separately purchased INFINITI InTouch™ Services subscription is required. For detailed information, contact an INFINITI retailer or refer to the following INFINITI InTouch™ Services website:

For U.S.

www.infiniti.com/intouch

For Canada

<https://www.infiniti.ca/intouch> (English)

<https://fr.infiniti.ca/intouch> (French)



INFO:



If the vehicle is owned by another person and is resold, the subscription for this service must be canceled and all data stored on the device must be deleted.

Operating tips



WARNING

- **Use the INFINITI InTouch™ Services after stopping your vehicle in a safe location. If you have to use the INFINITI InTouch™ Services while driving, exercise extreme caution at all times so full attention may be given to vehicle operation.**
- **If you are unable to devote full attention to vehicle operation while talking with the INFINITI InTouch™ Services, pull off the road to a safe location and stop your vehicle.**
- Do not use the INFINITI InTouch™ Services with the engine stopped. Doing so may discharge the vehicle battery.
- The INFINITI InTouch™ Services cannot be used under the following conditions:
 - The INFINITI InTouch™ Services subscription has expired.
 - The vehicle is outside the area where the cellular network service is receivable.

- The vehicle is in a location with poor signal reception such as tunnels, underground parking garages, behind buildings or in mountainous areas.
- The line is busy.
- The TCU (Telematics Control Unit) or other systems of your vehicle are not working properly.
- The INFINITI InTouch™ Services network system is disabled.
- Information feeds download cannot be used when the vehicle is connected to the INFINITI InTouch™ Services Data Center and INFINITI InTouch™ Services Response Center.
- Communication with the INFINITI InTouch™ Services Data Center is related to the data communication mode and may cause occasional difficulty in receiving signals, and the signal receivable area may be limited compared to regular mobile phones.
- You may hear clicks or experience interruptions while speaking with the INFINITI InTouch™ Services Response Specialists. This is due to a shift in the connection zone and is not a malfunction.
- Depending on the line used, the sound volume may decrease. Adjust the volume as necessary.
- Received sounds may be distorted or ambient noise may sound like voices of a crowd. This is due to the use of the digital line and is not a malfunction.
- You may hear your own voice from the speaker when talking with the INFINITI InTouch™ Services Response Specialists due to a network disturbance. When this occurs, reconnect the line after a few minutes or at a different location.
- This vehicle incorporates a communication device that is called a TCU (Telematics Control Unit). The communication connection between this unit and the INFINITI InTouch™ Services Data Center allows for various services. When the system connects to the INFINITI InTouch™ Services Data Center, an antenna icon will appear on the screen. Use the service in a location where the symbol representing good signal reception appears on the screen.
 -  : When the signal reception is good
 -  : When the signal reception is bad

- The INFINITI InTouch™ Services use the TCU (Telematics Control Unit) for communications. Even if the antenna icon indicates good reception, connection to the INFINITI InTouch™ Services Data Center may be disabled. This does not indicate a malfunction. Operate the system again after a few minutes.



INFINITI INTOUCH™ SERVICES MENU

With INFINITI InTouch™ Services, various information can be received and displayed on the screen. The information can also be announced by the system.

1. Push **<MENU>** and then touch [Information].
2. Touch [InTouch Services].
3. Select an item from the INFINITI InTouch™ Services menu screens.

Available items may vary depending on models, specifications and software versions.

5. Information and vehicle settings

Available items	Content
[Call INFINITI Assistance]	<p>The system connects to the INFINITI InTouch™ Services Data Center. Various services to support your driving are available by answering the Interactive Voice Menu.</p> <p> "Connecting to Interactive Voice Menu" (page 5-12)</p>
[History]	<p>Access the messages sent to the vehicle from the INFINITI InTouch™ Services Data Center.</p> <p> "History" (page 5-12)</p>
[InTouch Services Settings]	<p>INFINITI InTouch™ Services settings can be changed.</p> <p> "INFINITI InTouch™ Services settings" (page 5-14)</p>

Connecting to Interactive Voice Menu (if so equipped)

Various services to support your driving are available by using the Interactive Voice Menu. For more details, contact the INFINITI InTouch™ Services support line at 1-855-444-7244 or refer to the following INFINITI InTouch™ Services website:

For U.S.

www.infiniti.com/intouch

For Canada

<https://www.infiniti.ca/intouch> (English)

<https://fr.infiniti.ca/intouch> (French)

1. Push **<MENU>** and touch [Information].
2. Touch [InTouch Services].
3. Touch [Call INFINITI Assistance].
4. The system connects to the INFINITI InTouch™ Services Data Center and menu options will be announced. Speak your preferred option.

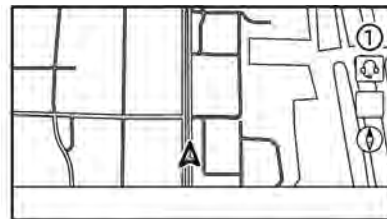

INFO:

- You can also connect to the INFINITI InTouch™ Services Interactive Voice Menu by touching  ① on the map.
- After selecting [Call INFINITI Assistance], it may take some time until the system initiates connection, depending on the technical environment and whether the TCU (Telematics Control Unit) is being used by other services.
- To avoid disconnecting the line, do not turn off the engine.

History

Messages received from the INFINITI InTouch™ Services Data Center are displayed.

1. Push **<MENU>** and then touch [Information].
2. Touch [InTouch Services].
3. Touch [History].
4. A message list is displayed. Touch preferred message from the list.



INFO:

- Touch [Stop] during communication with the INFINITI InTouch™ Services Data Center to cancel the connection.
- A message is displayed when the communication is disconnected while downloading information due to a poor communication status. Select [Yes] to restart the download.
- Laws in some jurisdictions may restrict the use of "Text-to-Speech". Check local regulations before using this feature.
- Some terminology such as personal names, place names, special terms, symbols, etc. may not be announced correctly. This is not a malfunction.
- The system will pause announcements when interrupted by the voice guidance given by the navigation system. When

the voice guidance finishes, the system will restart the announcement.

- The volume can be adjusted when the system announces the information.
 - ☞ "Volume and Beeps settings" (page 2-31)
- The selected content is read out while the vehicle is being driven, or if parked, you can read the content on the display.
- Content settings can be made using the INFINITI InTouch™ Services website. For more details, contact the INFINITI InTouch™ Services support line at 1-855-444-7244 or refer to the following INFINITI InTouch™ Services website:
 - For U.S.
www.infiniti.com/intouch
 - For Canada
<https://www.infiniti.ca/intouch> (English)
<https://fr.infiniti.ca/intouch> (French)

5. Information and vehicle settings

INFINITI INTOUCH™ SERVICES SETTINGS

The INFINITI InTouch™ Services setting can be changed.

Available menus may vary depending on models, specifications and software versions. Menus displayed on the screen may not function depending on various conditions.

1. Push **<MENU>**.
2. Touch [Information].
3. Touch [InTouch Services].
4. Touch [InTouch Services Settings].



INFO:

[InTouch Services] can also be accessed by pushing **<MENU>** and touching [Settings].

Menu	Action
[Delete All Information Feed History]	Deletes contents of information feeds.
[Vehicle Information sharing with Infiniti]	[Share Vehicle Information] Turns the vehicle information sharing function on/off.
	[Delete Shared Vehicle Data] Deletes the shared vehicle information.
[Unit ID Information]	Displays the Unit ID, TCU (Telematics Control Unit) ID, SIM ID and VIN Information necessary for user registration.
[Reset ALL InTouch Services Settings]	All INFINITI InTouch™ Services settings are returned to default.
[Vehicle Data Transmission Setting]	When [OK] is touched, data transmission to the INFINITI is enabled. Touch [Decline] to disable the INFINITI InTouch™ Services, Premium Traffic, Online Search, etc.

SiriusXM® TRAVEL LINK (if so equipped)

This service provides real-time information regarding current weather, fuel prices, parking information, sports scores, movie times and stock tickers.

It is necessary to subscribe to use the SiriusXM® Travel Link information.

The SiriusXM® Travel Link is broadcast to the vehicle by SiriusXM® Radio.



WARNING

SiriusXM® Travel Link information is not a substitute for attentive driving. Weather conditions change constantly and emergency situations can arise without warning. Relying only on SiriusXM® Travel Link information could result in serious personal injury.

VIEWING SiriusXM® TRAVEL LINK

SiriusXM® Radio and SiriusXM® Travel Link subscriptions are sold separately or as a package, and are continuous until you call SiriusXM® to cancel. See SiriusXM® Customer Agreement for complete terms at www.siriusxm.com

(for U.S.) or www.siriusxm.ca (for Canada). SiriusXM® Travel Link is available in select markets.

For more information, refer to the SiriusXM® website or call Listener Care.

SiriusXM® website:

For U.S.

www.siriusxm.com/travellink

For Canada

<https://www.siriusxm.ca/siriusxm-infotainment> (English)

<https://www.siriusxm.ca/fr/siriusxm-infodivertissement> (French)

Listener Care:

For U.S.

1-877-447-0011

For Canada

1-877-438-9677



INFO:

- If a subscription is not active for SiriusXM® Travel Link, a message appears on the display and information will not be available.

- SiriusXM® Travel Link information (such as Weather, Fuel, Parking, etc.) is available only for areas that the SiriusXM® provides this information.
- Not all vehicles or devices are capable of receiving all services offered by SiriusXM®. Data displays and individual product availability vary by vehicle hardware. Current information and features may not be available in all locations, or on all receivers. SiriusXM® is not responsible for any errors or inaccuracies in the data services or their use in the vehicle.

USING SiriusXM® TRAVEL LINK

1. Push **<MENU>**.
2. Touch [Information].

Items displayed on the screen may not function depending on various conditions.

5. Information and vehicle settings

Menu item		Result
[SXM Weather]	[Current Conditions]	Current, hourly or 5-day weather information is displayed. Weather information for nearby location, near the destination and your preferred city set as a Favorite City can be confirmed. Favorite city can be changed by touching [Change City].
	[Hourly Weather Forecast]	
	[5-Day Forecast]	
	[Graphical Map]	The weather forecast can be checked on the map. The detailed information is displayed by touching weather icons. Touch [Legend] to confirm the meaning of the color displayed, and touch [Filter] to select a type of the weather information.
	[Weather Alerts]	Displays the list of weather alerts. The detailed information is displayed by touching the weather alert. Touch [Voice Alert Settings] to select the information you wish to get alerts for and to set voice announcement on or off.
	[Alert Map]	The weather alerts can be confirmed on the map. The detailed information is displayed by touching the weather icon. Touch [Legend] to confirm the weather alerts displayed.
[SXM Traffic]/[Premium Traffic]		Displays the Traffic Information screen.  "Viewing traffic information" (page 6-40)
[SXM Sports Scores]		Various sports and individual teams can be followed. Touch [Sports] and select from the list to display information such as news, scores or upcoming games.
[SXM Stocks]		Stock information can be checked. Touching [Add Stock] will also allow adding a favorite stock. Once a stock is added, it's price and trend can be viewed. Red indicates the stock is down and green indicates the stock is up. Touch [Delete Stock] to delete the saved stocks. Up to 20 stocks can be saved. Only supported stocks can be added.
[SXM Fuel Prices]		Displays a list of the nearby gas stations for the current location or destination. Touch a listed gas station for the detailed information. Touch [Save] to register in a favorite, and the list is displayed by touching [Favorite]. Touch [Go Here] to set as a destination. Touch [Delete] to delete the favorite.

5. Information and vehicle settings

Menu item		Result
[SXM Parking]		Displays a list of the nearby parking areas for the current location or destination. Touch a listed parking area for the detailed information. Touch [Save] to register in a favorite, and the list is displayed by touching [Favorite]. Touch [Go Here] to set as a destination. Touch [Delete] to delete the favorite.
[SXM Movie Listings]	[Favorite Theaters]	Displays a list of favorite theaters. Select the theater for detailed information. Touch [Go Here] to set as a destination. Touch [Movies] on the list to display a list of movies that are playing at the theater. When touching a movie on the list, detailed information of the movie can be checked.
	[Nearby Theaters]	Displays a list of nearby theaters. Select the theater for detailed information. Touch [Go Here] to set as a destination. Touch [Save] to set the theater as a favorite theater which can be listed in the Favorite Theaters. Touch [Movies] on the list to display a list of movies that are playing at the theater. When touching a movie on the list, detailed information of the movie can be checked.
	[Current Movies]	Displays a list of movies that are currently playing. Touch a movie from the list to display detailed information. Touch [Theaters] to display the nearby theaters that are playing the selected movie. Select the theater from the list and touch [Go Here] to set as a destination. Touch save as a favorite. Touch [Movies] on the theater list to check the movies that is playing at the theater.
	[Search for a Theater]	Search for a theater or movie by inputting the name of the theater or movie.
	[Search for a Movie]	

5. Information and vehicle settings

Apple CarPlay®



WARNING

- **Stop your vehicle in a safe location and apply the parking brake before connecting your iPhone® to the vehicle or operating your connected iPhone® for setup.**
- **If you are unable to devote full attention to vehicle operation while using Apple CarPlay®, pull off the road to a safe location and stop your vehicle.**

You can use Apple CarPlay® by connecting a compatible iPhone® to your vehicle using a USB cable or wirelessly (if so equipped).

With Apple CarPlay®, your in-vehicle system can be used as a display and a controller for some of the iPhone® functions. Apple CarPlay® features Siri® which enables operations via voice controls. Visit Apple.com for information about the functions that are available and details about Apple's privacy policy.

Certain vehicle information (e.g. location and speed) may be shared with your device while

Apple CarPlay® is in use. Carrier charges may apply to use Apple CarPlay®.

COMPATIBILITY

The following iPhone® models support Apple CarPlay®.

Model	Firmware version
iPhone® 5 or later	iOS 8.4 or later

Refer to the Apple website for more information.



INFO:

- For best results, always update your device to the latest software version.
- Apple CarPlay® will take the place of your Bluetooth® audio and Bluetooth® Hands-Free Phone functionality.
- Phone menu and access to the connected phone through Voice Recognition System will be disabled while Apple CarPlay® is connected. To access your phone, use the Siri® function or select the phone icon in the Apple CarPlay® top menu screen.

- When setting a route on the navigation system (if so equipped), if you set a destination with Apple CarPlay®, the route setting of the navigation system will be cancelled.

CONNECTING iPhone®

This system supports wireless Apple CarPlay® (if so equipped). To connect Apple CarPlay® wirelessly, the Bluetooth® and Wi-Fi network (if so equipped) must be available with the in-vehicle system before operation.

 "Setting devices" (page 2-27)

 "Wi-Fi Setting" (page 2-29)



INFO:

Depending on the device and firmware version of the iPhone®, wireless Apple CarPlay® (if so equipped) cannot be used. Always update your device to the latest software version.

Connecting with the USB cable



INFO:

To connect your iPhone® with the in-vehicle system, it is recommended to use the Apple Lightning™ cable (Mfi certified) that was

provided with your iPhone®.

1. Connect the iPhone® to the USB connection port.
 - 🔗 "USB (Universal Serial Bus) connection ports and AUX (auxiliary) input jack" (page 2-7)
 - 🔗 "USB connection ports" (page 2-8)
2. Depending on the setting, a Startup Information screen will appear on the upper display. Touch [Yes] to use Apple CarPlay®.
3. Apple CarPlay® starts and the Apple CarPlay® screen appears on the upper display.
4. If a notification appears on the iPhone®, select whether or not to use the wireless connection. Once you enable wireless Apple CarPlay® (if so equipped) on the notification, Apple CarPlay® will automatically start wirelessly next time.

Connecting wirelessly (if so equipped)

1. Connect the iPhone® to the in-vehicle system via Bluetooth®.
 - 🔗 "Setting devices" (page 2-27)



INFO:

If no Bluetooth® device is connected and Apple CarPlay® or Android Auto is not active, pushing and holding <  > on the steering wheel can display the Connections screen.

2. Depending on the setting, a Startup Information screen will appear on the upper display. Touch [Yes] to use Apple CarPlay®.
3. A notification will appear on the iPhone®. Select to use the wireless connection.



INFO:

If you select not to use the wireless connection, the iPhone® will be connected as a Bluetooth® device.

4. Wireless Apple CarPlay® will start and the Apple CarPlay® screen appears on the upper display.



INFO:

If the Wi-Fi connection (if so equipped) is off on the Wi-Fi setting screen, a notification will appear on the upper display. Touch [Yes] to use wireless Apple CarPlay®.

🔗 "Wi-Fi Setting" (page 2-29)

Operating tips

- If you do not wish to display the Startup Information screen each time you activate Apple CarPlay®, turn on [Don't Ask Anymore] on the Startup Information screen. The Startup Information screen will not be displayed from the next Apple CarPlay® activation. The Startup Information screen can be set to appear again in the Apple CarPlay® setting menu.
 - 🔗 "Apple CarPlay® settings" (page 5-21)
- The system update or the map update will stop while using wireless Apple CarPlay® (if so equipped).
- The connection with the other Bluetooth® device may be disconnected when wireless Apple CarPlay® (if so equipped) is activated.
- Once the wireless connection has been established, Apple CarPlay® will be automatically connected wirelessly next time.
- Wireless Apple CarPlay® (if so equipped) uses the Wi-Fi network (if so equipped). After connecting the in-vehicle system to

5. Information and vehicle settings

the Wi-Fi network, the Bluetooth® connection with wireless Apple CarPlay® (if so equipped) connected device will be disconnected.

- If you connect the iPhone® to the USB connection port with USB cable while using wireless Apple CarPlay® (if so equipped), the battery of the iPhone® will be charged.
- If wireless Apple CarPlay® (if so equipped) does not start automatically, touch [⏏] on the device settings screen.
👉 "Setting devices" (page 2-27)
- If you are using Apple CarPlay® or Android Auto, you cannot start Apple CarPlay® with the other iPhone®. To use Apple CarPlay® with the other iPhone®, disconnect the current device, or deactivate Apple CarPlay® or Android Auto on the Connections settings.
👉 "Connections settings" (page 2-27)

Apple CarPlay® OPERATION

After starting Apple CarPlay®, the iPhone® functions displayed on the screen can be operable using the in-vehicle system.

To exit Apple CarPlay® screen, push the buttons such as <MAP/VOICE> (if so equipped) on the INFINITI controller .

To return to the Apple CarPlay® screen, take one of the following actions.

- Push <MENU> and touch [Apple CarPlay] on the lower display.
- Touch [Apps] on the information screen, and then touch [Apple CarPlay].



INFO:

- When your iPhone® is locked, Apple CarPlay® can still be activated by operating the iPhone® and allowing Apple CarPlay® activation.
- The in-vehicle system can be used on the lower display even if Apple CarPlay® is activated.

Siri® operation

With Siri®, some of the functions in your iPhone® can be voice controlled.

Make sure that Siri® on your iPhone® is turned on.

Activation:

Push and hold <🗣️> on the steering wheel to start a Siri® session.



INFO:

- Push <🗣️> to end Siri® operation.
- Keep the interior of the vehicle as quiet as possible. Close the windows to eliminate the surrounding noises (traffic noises, vibration sounds, etc.), which may prevent the system from recognizing the voice commands correctly.
- For functions that can be used with Siri®, refer to the Apple website.

Phone operation

If you wish to use the phone with Apple CarPlay®, follow the procedure below:

1. Touch [Phone] on the Apple CarPlay® top menu.

- Operate the screen displayed to make a call, etc.

Apple CarPlay® SETTINGS

- Push <MENU>.
- Touch [Connections] and touch [Devices].
- Touch [1] by the iPhone® name you wish to change the settings.
- Touch [Smartphone Projection].

Available setting items:

Setting item 1	Setting item 2	Action
[Start-up Options]	[Auto]	Activates Apple CarPlay® automatically when an iPhone® is connected to the in-vehicle system.
	[Ask Every Time]	Displays the Startup Information screen when an iPhone® is connected to the in-vehicle system.
	[Never Start]	Apple CarPlay® will not activate even if an iPhone® is connected to the in-vehicle system.
[Vehicle's Help for Apple CarPlay]		Displays helpful tips for Apple CarPlay® operation.



INFO:

- [Vehicle's Help for Apple CarPlay] can also be accessed from Apps menu.
 "Information menu" (page 5-2)
- Normal voice recognition access to songs on your iPod® will not be available when connected to Apple CarPlay®. To access to your iPod®, use the Siri® function or select the music icon in the Apple CarPlay® top menu screen.
 "Siri® operation" (page 5-20)

5. Information and vehicle settings

Apple CarPlay® SYSTEM LIMITATIONS

For all features of Apple CarPlay® to operate correctly, it is necessary to have a compatible iPhone®, a cellular connection and a data plan.

When Apple CarPlay® is operating, system performance is affected by the strength of the cellular connection or performance of the phone itself. If performance of the system decreases:

- Disconnect and reconnect your phone
- Cycle phone power off/on to restart

Changing government regulations may also affect operation of Apple CarPlay®.

Android Auto™



WARNING

- **Stop your vehicle in a safe location and apply the parking brake before connecting your Android™ phone to the vehicle or operating your connected Android phone for setup.**
- **If you are unable to devote full attention to vehicle operation while using Android Auto, pull off the road to a safe location and stop your vehicle.**

You can use Android Auto by connecting a compatible Android phone to your vehicle via a USB cable. It is also recommended to use the Android phone OEM cable that is compatible with your phone.

With Android Auto, your in-vehicle system can be used as a display and a controller for some of the Android phone functions. Voice control of some of the Android phone functions is also possible with Android Auto. Visit www.android.com/auto for information about the functions that are available and details about Google's privacy policy.

Certain vehicle information (e.g. location and speed) may be shared with your device while Android Auto is in use. Carrier charges may apply to use Android Auto.

COMPATIBILITY

Only Android 6.0 (Marshmallow) or later versions are compatible with Android Auto. Refer to the Android Auto website for more information.



INFO:

- Download the Android Auto App from Google Play™ to Android phone in advance.
- For best results, always update your device to the latest Android software and Android Auto App version. When you connect the Android phone to the in-vehicle system, it will automatically update the Android software and Android Auto App version.
- Android Auto will take the place of your Bluetooth® audio and Bluetooth® Hands-Free Phone functionality.
- When setting a route with the navigation system (if so equipped), if you set a destination with Android Auto, the route

setting of the navigation system will be cancelled.

- The Phone menu and access to the connected phone through the Voice Recognition System will be disabled while Android Auto is connected. To access your phone, talk to your Google Assistant or select the phone icon in the Android Auto top menu screen.

INITIAL Android Auto SETTINGS



Before using Android Auto, download the Android Auto app from the Google Play store on your Android phone.

It may be necessary to operate the Android phone when connecting first.

Depending on the selection on the connecting Android phone, such as approval, some of the features of Android Auto are not available.

Android Auto OPERATION

Unlock your phone's screen before connecting your Android phone.

1. Connect your Android phone to the USB connection port.
 -  "USB (Universal Serial Bus) connection ports and AUX (auxiliary) input jack" (page 2-7)
 -  "USB connection ports" (page 2-8)
2. Depending on the setting, a Startup Information screen will appear on the upper display. Touch [Yes] to use Android Auto.



INFO:

- If you are using Android Auto or Apple CarPlay®, you can not start Android Auto with the other Android phone. To use the Android Auto with the other Android phone, disconnect the current device, or deactivate Android Auto or Apple CarPlay® on the Connections settings.
 -  "Connections settings" (page 2-27)
- If you do not wish to display the Startup Information screen each time you activate Android Auto, turn on

[Don't Ask Anymore] on the Startup Information screen. The Startup Information screen will not be displayed from the next Android Auto activation. The Startup Information screen can be set to appear again in the Android Auto setting menu.

 "Android Auto settings" (page 5-25)

- The Bluetooth® setting of your Android phone will be turned on and connected to in-vehicle system automatically when Android Auto is activated. Keep the Bluetooth® turned on to use the phone functions.
 - Some functions of Android Auto are not available if the Bluetooth® is not connected.
3. The Android Auto top menu screen will appear on the upper display. The Android phone functions displayed on the screen should now be operable using the in-vehicle system.



INFO:

- When pushing the buttons such as <MAP/VOICE> (if so equipped) on the INFINITI controller, the

5. Information and vehicle settings

corresponding display to the button is displayed on the upper display.



INFO:

- While Android Auto is activated on the Android phone, the phone operations, such as making or receiving calls, can only be done with Android Auto.
- Depending on the device, an Android phone requires MTP mode to be selected in the USB transfer setting.
- The in-vehicle system can be used on the lower display even if the Android Auto is activated.
- After exiting the Android Auto screen, return to the Android Auto screen by taking one of the following actions.
 - Push **<MENU>** and touch [Android Auto].
 - Touch [Apps] on the information screen, and then touch [Android Auto].

Google Assistant™ operation

Some of the functions on your Android phone can be voice controlled when Android Auto is active.

Activation:

Push and hold **< ʌ >** on the steering wheel to start a Google Assistant session.



INFO:

- Push **< ʌ >** to end voice operation.
- Keep the interior of the vehicle as quiet as possible. Close the windows to eliminate the surrounding noises (traffic noises, vibration sounds, etc.), which may prevent the system from recognizing the voice commands correctly.
- For functions that can be used with the voice operation, refer to www.android.com/auto.

Phone operation

If you wish to use your phone while Android Auto is activated, follow the procedure below:

1. Touch **[☎]** on the Android Auto screen.

2. Operate the screen displayed to make a call, etc.

Android Auto SETTINGS

1. Push <MENU>.
2. Touch [Connections] and touch [Devices].
3. Touch [] by the Android phone name you wish to change the settings.
4. Touch [Smartphone Projection].

Setting item 1	Setting item 2	Action
[Start-up Options]	[Auto]	Activates Android Auto automatically when an Android Phone is connected to the in-vehicle system.
	[Ask Every Time]	Displays the Startup Information screen when an Android Phone is connected to the in-vehicle system.
	[Never Start]	Android Auto will not activate even if an Android Phone is connected to the in-vehicle system.
[Vehicle's Help for Android Auto]		Displays helpful tips for Android Auto operation.



INFO:

[Vehicle's Help for Android Auto] can also be accessed from Apps Menu.

☞ "Information menu" (page 5-2)

5. Information and vehicle settings

Android Auto SYSTEM LIMITATIONS

For all features of Android Auto to operate correctly, it is necessary to have a compatible Android phone, a cellular connection and a data plan.

When Android Auto is operating, system performance is affected by the strength of the cellular connection or performance of the phone itself. If performance of the system decreases:

- Disconnect and reconnect your phone
- Close all apps and restart them
- Cycle phone power off/on to restart

It should also be confirmed that the latest version of both Android OS and the Android Auto App are installed on the cellular phone.

Functionality of Android Auto may decrease or be lost if there are changes to operating systems, hardware, software or other technologies central to supporting the system that are outside of INFINITI's control. Changing government regulations may also affect the operation of Android Auto.

SIRI® EYES FREE

GENERAL INFORMATION

Apple Siri® Eyes Free personal assistant can be accessed from the vehicle. Siri® Eyes Free can be accessed in Siri® Eyes Free mode to reduce user distraction. In this mode, Siri® Eyes Free is available for interaction by voice control. After connecting a compatible Apple device by using Bluetooth®, Siri® Eyes Free can be activated by pushing and holding <  > on the steering wheel.

Siri® is a trademark of Apple Inc., registered in the U.S. and other countries.



INFO:

- Some Siri® Eyes Free functions, such as opening apps, may not be available during driving.
- For best results, always update your device to the latest software version.
- Keep the interior of the vehicle as quiet as possible. Close the windows to eliminate the surrounding noises (traffic noises, vibration sounds, etc.), which may prevent the system from recognizing the voice commands correctly.

- For functions that can be used in Siri® Eyes Free, refer to the Apple website.

REQUIREMENTS

Siri® is available on the iPhone® 4S or later. Devices released before iPhone® 4S are not supported by the Siri® Eyes Free system.

Visit www.apple.com/ios/siri for details about device compatibility.



Siri® must be enabled on the phone. Please check phone settings.

If the device has a lock screen, Siri® must be accessible from the lock screen. Please check phone settings.

SIRI® EYES FREE ACTIVATION

Siri® Eyes Free function can be activated using <  > on the steering wheel.

 "Control buttons and touch screen display" (page 2-2)

1. Connect a Siri® Eyes Free enabled iPhone® to the vehicle.
 "Setting devices" (page 2-27)
2. After the Bluetooth® connection is established, push and hold <  > on the steering wheel to activate the Siri® Eyes Free function.

OPERATING SIRI® EYES FREE

1. Push and hold <  > on the steering wheel.
2. Speak your command and then listen to the Siri® Eyes Free reply.

After starting Siri® Eyes Free, push <  > on the steering wheel again within 5 seconds of the end of the Siri® Eyes Free announcement to extend the session.

Example 1 - Playing music

1. Push and hold <  > on the steering wheel.
2. Say "Play (artist name, song name, etc.)".
3. Your vehicle will automatically change to Bluetooth® audio or iPod® mode* when the music starts playing. Mode selection is determined by the phone.

*: If the iPhone® is also connected with the USB cable.

If the audio track does not start playing automatically after Siri® Eyes Free ends, try changing the track or audio source to resume playback.



NOTE:

For best results, use the native music app. Performance of music control function while using Podcasts, Audiobook or other third party music apps may vary and is controlled by the iPhone®.

Example 2 - Replying to text messages

1. If a compatible iPhone® is connected and "Show Notifications" of the iPhone® settings is enabled, the vehicle will display a notification for new incoming text messages.
2. After reading the message, push and hold <  > on the steering wheel.
3. After a beep sounds, say "Text message" or a similar command to reply to the received message using Siri® Eyes Free.

TOMTOM WEATHER INFORMATION

The real-time weather information can be checked.

The TomTom Weather information can be used with the following procedure.

1. Push < **MENU** >.
2. Touch [Information].

5. Information and vehicle settings

Menu item		Action
[TomTom Weather]	[Current Conditions]	Current, hourly or 5-day weather information is displayed.
	[Hourly Weather Forecast]	Weather information for nearby location, near the destination and your preferred city set as a Favorite City can be confirmed.
	[5-Day Weather Forecast]	Current, hourly or 5-day weather information can be changed by touching [☀️], [🌧️] or [🌨️]. Nearby location, near the destination and your preferred city can be changed by touching [Nearby], [Near Dest.] or [Favorite City]. Favorite City can be changed by touching [Change City].
	[Communication Settings]	Turns the TomTom Weather data transmission on/off.

FULLY CUSTOMIZABLE DIGITAL ENVIRONMENT

The system will automatically recognize the user upon turning on the system after setting up the user information. There will be a personalized welcome message.

This feature allows 3 drivers to use their own registration, such as air conditioner, audio, etc. settings, and memorizes these custom settings (available setting items may vary depending on models, specifications and software versions.).

Log-in user can be changed from User Profiles screen.

NOTE:

- A maximum of four Intelligent Keys can be registered to store settings for three profiled users and one guest. One user setting information can be stored per key.
- When the ignition switch is placed in the OFF position, the user settings at that point will be memorized by the Intelligent Key that is used.

USER REGISTRATION

Up to three users can be registered.

1. When a system is started with an Intelligent Key that had not been registered, a message asking if you wish to register yourself as a user is displayed.
2. Touch [Yes] on the user registration screen to register.
3. The New User register screen is displayed. Enter the user information.
4. After inputting user information, touch [Save] to complete user registration.

INFO:

- Do not place the ignition switch in the OFF position during user registration. The registration may not complete.
- If [Later] is selected on the pop-up message screen, the user will log in as a guest. If the same Intelligent Key is used again the next time the vehicle is used, the same pop-up message will be displayed. If [No] is selected, the user will log in as a guest and the pop-up message will not be displayed again with the same Intelligent Key.

INFO:

To change the registered user information, push <MENU> then touch [INFINITI InTuition] to show [User Profiles] where the user can be selected for editing.

EDITING USER INFORMATION

Push <MENU> and touch [👤] on the lower right of the lower display to show User Profiles screen.

User Profiles screen:

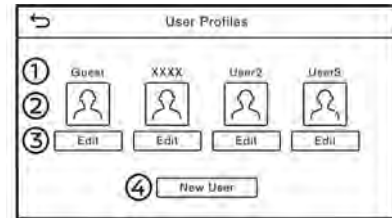



- ① Name: Display user name.
- ② User icon: Display user select icon. Touch to change log-in user.
- ③ [Edit]: Select to edit user settings.

5. Information and vehicle settings

④ [New User]:

Add a new user. It can register a maximum three persons. This key will not be displayed when three users have been already registered.

INFO:

- User name and user icon of the guest user cannot be edited.
-  is also displayed on climate and audio screen on the lower display.
- Change the user while the vehicle stops.
- The User Profiles screen can also be accessed by touching [INFINITI InTuition] on the MENU screen, and then touching [User Profiles].
 "How to view and operate MENU screen" (page 2-17)

User edit screen

Touching [Edit] on the User Profiles screen will display the user edit screen.



Available setting items may vary depending on models, specifications and software versions.

Available setting items

Setting item	Action
Name	Edit the user name by touching [Edit User Name].
Icon	Edit the user picture by touching [Change Icon]. The user icon can be selected from the pre-installed pictures and registered via a USB memory device.

Intelligent-Key No.	Indicates the key number. The key icon that is highlighted indicates that the key is linked to the user. The "▼" mark above the key icon indicates which one of the keys is currently being used.
[Copy]	Copy user settings. Following settings can be copied. <ul style="list-style-type: none"> • Navigation and audio settings • Driver assistance settings • PERSONAL Mode settings • Air conditioner settings • Automatic drive positioner • Vehicle settings • Meter settings • Head Up Display settings
[Delete]	Delete a user.

INFO:

- The number of characters for the user name is limited.
- When a current user is deleted, the user is changed to a guest user.

Change the user picture

When you connect a USB device with image data, you can download image and setting picture.

1. Display the user edit screen and touch [Change Icon] beside the icon.
2. Connect USB device and touch [+].
3. Touch preferred picture file name.
4. Touch [Select] to setting user picture.

When display picture-preview screen, touch [Update Only] to only update picture list from USB device.

SETTING INFINITI INTUITION FEATURE

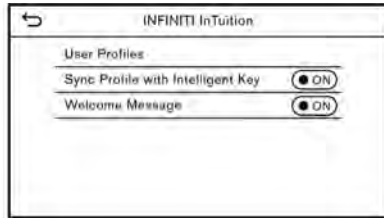

Push **<MENU>** and touch [INFINITI Intuition].

The following items can be set.

- [User Profiles]
Edit user information, copy user settings and delete user setting.
☞ "Editing user information" (page 5-29)
- [Sync Profile with Intelligent Key]
Turn on or off Intelligent Key link function.
- [Welcome Message]
Set the welcome message on or off.
☞ "Log-in screen" (page 2-9)

INFO:

- When [Sync Profile with Intelligent Key] is turned off, the users will be logged in as a guest.
- When [Sync Profile with Intelligent Key] is turned on from off, the user remains a guest. Select the preferred user from the User Profiles screen.
☞ "Editing user information" (page 5-29)
- When [Sync Profile with Intelligent Key] is turned off, the welcome message will not be displayed.

5. Information and vehicle settings

DRIVER ASSISTANCE SETTINGS

Various functions for supporting your drive can be set. Refer to the vehicle Owner's Manual for the details of each function.

The displayed items vary depending on models, specifications and software versions.

Step 1	Step 2	Setting Item		Action
Push <MENU>	[Driver Assistance]	[VDC]		Turns Vehicle Dynamic Control (VDC) on/off.
		[Forward Assist]	[Distance Control]	Sets Distance Control Assist enabled/disabled.
		[Lane Assist]	[Lane Departure Warning]	Turns Lane Departure Warning enabled/disabled.
			[Lane Intervention]	Sets Lane Departure Prevention enabled/disabled.
			[Active Lane Control]	Setting Active Lane Control enabled/disabled.
			[Active Lane Control Setting]	Setting Active Lane Control setting [High]/[Low].
		[Blind Spot Assist]	[Blind Spot Warning]	Turns Blind Spot Warning enabled/disabled. For models with Rear Cross Traffic Alert, Rear Cross Traffic Alert is also turned on/off.
			[Blind Spot Intervention]	Sets Blind Spot Intervention enabled/disabled.
			[Blind Spot Indicator]	Sets Side Indicator Brightness from [Bright], [Standard] or [Dark].
		[Lane Centering Assist]	[Steering Assist]	Turns Steering Assist on/off.

5. Information and vehicle settings

Step 1	Step 2	Setting Item		Action
		[Emergency Assist]	[Emergency Braking]	Turns Forward Emergency Braking/Predictive Forward Collision Warning on/off. The Forward Emergency Braking system will be automatically turned ON when the engine is restarted.
			[Forward]	
			[Backward]	Turns Rear Automatic Braking on/off. The Rear Automatic Braking system will be automatically turned ON when the engine is restarted.
		[Traffic Sign Assist]	[Traffic Sign Assist]	Turns the Traffic Sign Recognition on/off.

 **NOTE:**

It is necessary to push the dynamic driver assistance switch on the steering wheel, to turn on the Vehicle Dynamic Control (VDC), Distance Control Assist, Active Lane Control, Lane Departure Prevention and Blind Spot Intervention.

5. Information and vehicle settings

INFINITI DRIVE MODE SELECTOR SETTINGS

Various functions for the INFINITI Drive Mode Selector can be set. Refer to the vehicle Owner's Manual for the details of each function. The displayed items vary depending on models, specifications and software versions.

Step 1	Step 2	Setting Item	Action
Push <MENU>	[INFINITI Drive Mode Selector]	[Engine/Transmission]	Sets the Engine/Transmission settings.
		[Steering]	Sets the Steering settings.
		[Suspension]	Sets the Suspension settings.
		[Active Trace Control]	Turns Active Trace Control on/off.
		[Active Lane Control]	Selects Active Lane Control setting from [High] or [Low].
		[Active Engine Brake]	Turns Active Engine Brake on/off.
		[Reset Drive Mode Settings to Default]	All the INFINITI Drive Mode Selector settings are returned to default.

6 Navigation (if so equipped)

Safety information	6-3	Setting by phone number	6-23
Map operation	6-3	Setting from saved routes	6-23
Map types	6-3	Setting with SiriusXM® Travel Link	6-24
Road color	6-6	Setting point on map	6-25
Displaying current vehicle location	6-6	Setting with latitude/longitude	6-25
Moving map	6-6	Options before starting the route guidance	6-26
Changing scale of map	6-7	Route guidance	6-27
Changing map	6-8	About route guidance	6-27
Map settings	6-9	Route options menu	6-30
Setting information on map	6-13	Canceling Route	6-33
Traffic information on map	6-14	Displaying Turn List	6-33
Setting destination	6-14	Setting detour route	6-33
Basic operations	6-14	Route Preference	6-34
Free Text Search	6-17	Recalculating route	6-36
Setting home or work location as destination	6-17	Editing route	6-36
Finding address	6-18	Guidance settings	6-39
Finding points of interest	6-18	Viewing traffic information	6-40
Searching from previous destinations	6-20	SiriusXM Traffic™ (if so equipped)	6-40
Searching from address book	6-21	Premium Traffic information	6-41
Setting destinations by Google™	6-21	Viewing available traffic information	6-42
Setting city center	6-22	Traffic information setting	6-43
Setting with INFINITI InTouch™ Services (if so equipped)	6-22	Storing a location/route	6-44
Setting intersection	6-22	Storing location	6-44
		Storing route	6-45
		Storing avoid area	6-46

Editing stored information	6-47
Deleting stored item	6-50
Navigation settings	6-53
General information for navigation system	6-55
Current vehicle location	6-55

Route guidance	6-58
Route calculation	6-60
How to update map data	6-61

SAFETY INFORMATION

The navigation system is primarily designed to help you reach your destination. However, you, the driver, must use the system safely and properly. Information concerning road conditions, traffic signs and the availability of services may not always be up to date. The system is not a substitute for safe, proper, and legal driving.



WARNING

Do not rely on route guidance alone. Always be sure that all driving maneuvers are legal and safe in order to avoid accidents.

MAP OPERATION

MAP TYPES

Maps are displayed on the upper touch screen display (upper display).

Two types of map views are available: 2D and 3D.

2D map

The 2D map displays the map in a two-dimensional environment similar to a road map.

6. Navigation (if so equipped)

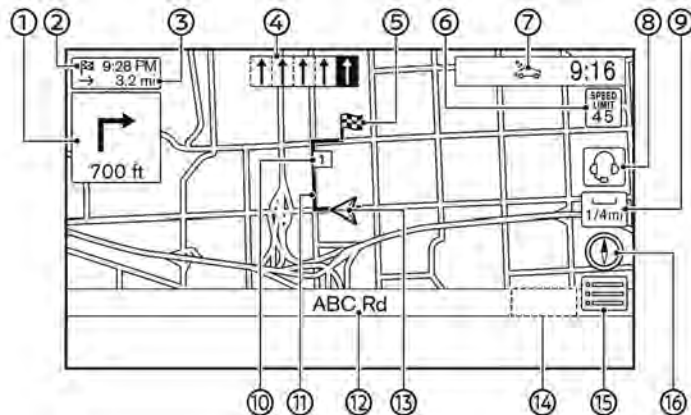

Example

Screen information:

① Arrow and distance:

Indicates the distance to the next guide point (intersection or corner) and the turning direction at that guide point.

Touch to repeat voice guidance.

If the current vehicle position is off the route, an arrow indicating the direction to the nearest route may be displayed instead of displaying the next turn arrow/distance.

② Remaining time/Time of arrival:

Indicates the remaining time or the estimated arrival time to the destination. Touch to switch the indicator to the remaining time/estimated arrival time to the waypoint.

The remaining time or arrival time display can be selected to your preference. "Route Preference" (page 6-34)

This indicator will appear when a destination or a waypoint is set and route guidance is started.

③ Remaining distance to the destination:
Indicates the approximate remaining distance to the destination or the waypoint. Touch to switch the indicator between the distance to the destination or the distance to the waypoint. This indicator will appear when a destination or a waypoint is set and route guidance is started.

④ Recommended lane indicator:
When a route is set, the arrow and the recommended driving lane may be displayed in blue depending on the road.

⑤ Destination:
Indicates the location of the final destination.







⑥ Speed limit icon:
Displays the speed limit of the current driving road.





⑦ INFINITI InTouch™ Services antenna icon:



When the system connects to the INFINITI InTouch™ Services Data Center, an antenna icon will appear on the screen.

"INFINITI InTouch™ Services" (page 5-7)

6. Navigation (if so equipped)

- ⑧  (if so equipped):
Touch the icon to connect to the INFINITI InTouch™ Services Voice Menu.
 "Connecting to Interactive Voice Menu" (page 5-12)
- ⑨  Scale indicator:
Indicates the scale of the map.
Touch the icon to display the scale bar. The map scale can be adjusted using the scale bar.
 "Changing scale of map" (page 6-7)
- ⑩  Waypoint:
Displays the location of the waypoint that the vehicle will stop by before heading to the final destination.
- ⑪ Suggested route:
Appears in bold blue during route guidance.
- ⑫ Street name:
Displays the name of the street that the vehicle is currently driving on.
- ⑬  Vehicle icon:
Indicates the current vehicle location and the direction of travel.

- ⑭ Traffic indicator:
Indicates the reception condition of the traffic information.
Touch to display the traffic information screen.
 "Viewing traffic events from list" (page 6-42)
[PREMIUM TRAFFIC]:
Displayed when [Use Premium Traffic] is turned on and the traffic information is available.
 "Traffic information setting" (page 6-43)
[SiriusXM TRAFFIC]:
Displayed when [Use Premium Traffic] is turned off and the traffic information is available.
 "Traffic information setting" (page 6-43)
A SiriusXM Traffic™ subscription is necessary to receive SiriusXM® information services.
- ⑮ :
Touch the icon to display the shortcut menu.
 "Shortcut menu" (page 2-12)

- ⑯ :
Indicates the directional setting of the map.
Touch to change the map view and the map orientation.
 "Changing map view and map orientation" (page 6-8)

3D map

The 3D map displays the map from an elevated perspective. In 3D map, it is easy to recognize an image of the route because it provides a panoramic view over a long distance.

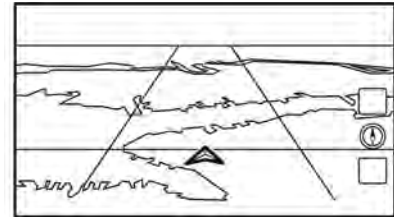

INFO:

The 3D map always appears with the current forward direction facing up.

6. Navigation (if so equipped)

Building graphics

Building graphics are stored in the map data for certain areas, and can be displayed when the map is zoomed in.

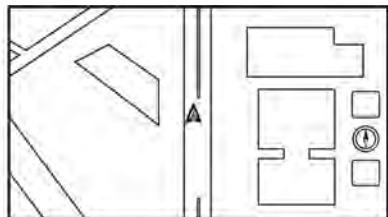

2D building graphics

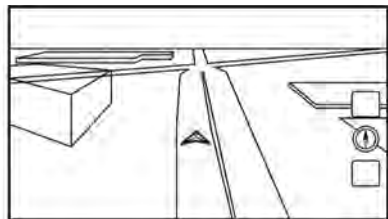

3D building graphics

INFO:

In an area where the building graphics are not stored in the map data, the normal map is displayed even when the map is zoomed in.

ROAD COLOR

The road types are differentiated by color.

Color	Road type
Dark red	Freeway
Light brown	Major road
Yellow	Secondary road
White	Local road

DISPLAYING CURRENT VEHICLE LOCATION

Operating with INFINITI controller

The basic map screen displays the current location (the position where the vehicle icon is located). Push **<MAP/VOICE>** on the INFINITI controller to display the current location on the map while on any screen.

 "INFINITI controller (Type A)"
(page 2-4)

 "INFINITI controller (Type B)"
(page 2-5)

Operating with touch panel operation

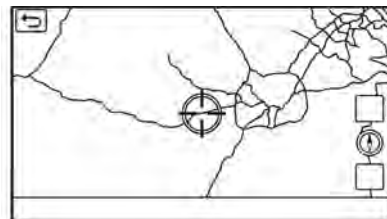

After moving the map, touch [] on the map screen to display the current location map screen.

MOVING MAP

The map can be scrolled by the touch panel operations. Map scrolling operations may be limited while driving.

Touch:

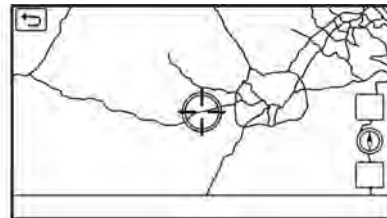

When a point on the map is touched, the cross pointer is displayed and the position touched is moved to the center of the screen.

Long touch:

Touch the direction to move to. The map continues to scroll while the screen is touched.

Drag:

Drag the screen to scroll the map.

Swipe/flick:

Swipe or flick the screen to scroll the map screen quickly.

Using INFINITI controller:

1. Slide the slide switch to move continuously across the map in a direction.
2. While moving on the map, the cross pointer appears.



INFO:

- 3D map can be displayed by dragging with two fingers in scrolled 2D map.
- Map scrolling operations are limited and not fully available while driving.

CHANGING SCALE OF MAP

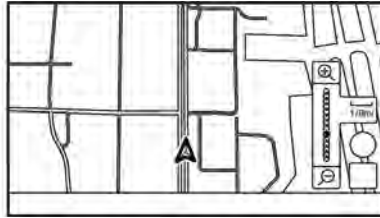

The scale bar can be displayed by touching the scale indicator on the map.

1. Touch [Map Scale Icon]. The scale bar is displayed.
2. Touch [Zoom In Icon] or [Zoom Out Icon] on the scale bar to change the map scale.

Using INFINITI controller:

Turning the center dial on the INFINITI controller can also change the map scale.

- Turn the center dial when the map screen is displayed.
- Use the center dial to adjust the map scale.
Clockwise: Zoom in
Counterclockwise: Zoom out

Free zoom:

Depending on the setting, using the center dial to change the map scale may adjust the scale normally, or it may engage the free zoom (finer scale adjustment in smaller steps).

👉 “Map settings” (page 6-9)



INFO:

Touching and holding [Zoom In Icon] or [Zoom Out Icon] on the scale bar can also use the free zoom.

Changing map scale while moving map

The map scale can also be changed by directly touching the map. Touch the map to display the cross pointer before performing the scale change.

Pinch-in:

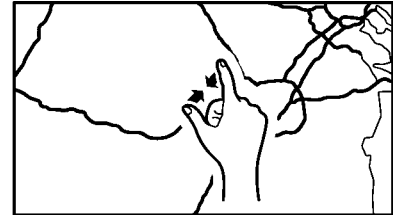

6. Navigation (if so equipped)

To view a wider area, pinch-in the map screen.

Pinch-out:



To view the map in detail, pinch-out the map screen.

INFO:

- While driving, pinch-in and pinch-out operations may be disabled.
- Depending on the map scale, traffic information icons cannot be displayed on the map screen.
 -  "Traffic information on map" (page 6-42)

CHANGING MAP

Changing map view and map orientation

The map view and the map orientation can be changed by touching  on the map screen.

The screen will change to North Up, Heading Up and 3D each time  is touched.



North Up



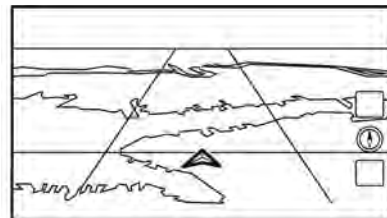

Heading Up



3D

INFO:

- You can also change the map view from the map view settings screen.
 -  "Map settings" (page 6-9)
- A long range map is available that displays a wider area in the direction the vehicle is moving in the Heading Up view.
 -  "Map settings" (page 6-9)

Setting split screen

It is possible to view the two types of map view or the map view, and other information at the same time. The right screen displays the map screen, and the left screen displays a turn list or an information screen.

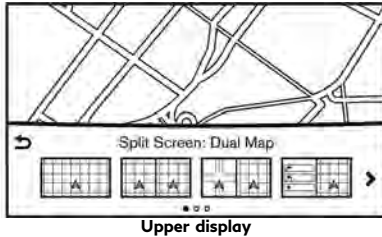

MAP SETTINGS

The setup for the map view is performed from the Settings menu on the touch screen display.

1. Push **<MENU>** and touch [Settings].
2. Touch [Navigation] and touch [Map Settings].

1. Push **<MAP/VOICE>** on the INFINITI controller while the current location map screen is displayed, the display view bar is displayed.

 "Changing display view"
(page 2-14)

2. Select the screen you would like to set.

6. Navigation (if so equipped)

Available setting items may vary depending on models, specifications and software versions.



Available setting items

Menu item	Action
[Split Screen View]	[Change Order]
	[Full Map]
	[Split Screen: Dual Map]
	[Intersection]
	[Turn List]
	[Where Am I?]
	[Split Screen: Turn by turn]
	[Fuel Economy]
	[Audio]
	[TomTom Current Conditions]
	[TomTom 5-Day Weather Forecast]
	[TomTom Hourly Weather Forecast]
	[SXM Current Conditions]
	[SXM 5-Day Weather Forecast]
	[SXM Hourly Weather Forecast]
	[SXM Sports Scores]
	[Analog Clock]
	[Digital Clock]
	Change the display order of the display view bar items.
	Display full map screen.
	Select a split screen view to be applied.  "Changing display view" (page 2-14)

6. Navigation (if so equipped)

Menu item		Action
[Map Icons]		Select the categories of POI icons to display on the map screen.  "Displaying map icons" (page 6-13)
[Map View]	[North Up]	Select one of the map views to be applied to the map screen.
	[Heading Up]	
	[3D Map]	
[Long Range]		The position of the vehicle icon is located slightly lower than the center of the screen to view a wider area in the traveling direction. Long Range is available only when the map view is in [Heading Up] mode.
[Left Split Map Settings]	[Map Orientation]	The map orientation for the left side of split screen can be selected from [North Up] or [Heading Up].
	[Long Range]	With this item turned on, the vehicle position icon on the left screen will be located slightly lower than the center of the screen so that a wider area in the traveling direction can be viewed. Long Range Map View is available only when the left side of split screen is in [Heading Up] mode.
	[Map Scale]	Sets the map scale of the left screen.
[Audio Display on Map]		Turns on/off the audio information displayed at the bottom of the map screen.
[Map Color]		Sets map color from standard, emphasize roads, emphasize text and emphasize traffic.
[Map Text Size]	[Large]	Sets the font size of the text displayed on the map screen.
	[Medium]	
	[Small]	

6. Navigation (if so equipped)

Menu item		Action
[Select Text to Display on Map]	[Place Names]	Allows place, facility and road names to be displayed on the map screen.
	[Facility Names]	
	[Road Names]	
[Map Scrolling Information]		Information about the location, on which the center of the cross pointer is placed by scrolling on the map, can be set to be displayed.  "Displaying map scrolling information" (page 6-13)
[Tracking Dots Displayed on Map]	[Record & Show Tracking Dots on Map]	Turns the route tracking dots display on/off.
	[Tracking Dot Distance]	Select the interval between tracking dots.
	[Delete Track to Current Location]	Deletes the route tracking dots up to the current location.
[Small Step Zoom with Dial]		Sets the free zoom function on or off. It is possible to adjust the scale in smaller steps than with normal scale adjustment.
[Show all Freeway Exits on Route]		Turns on/off the freeway exit information display. When this setting is ON, the freeway exit information is displayed on the turn list.
[Auto. Show Turn List on Freeway]		The turn list can be displayed automatically while driving on a freeway.  "Turn list" (page 6-29)
[North Up when Zoomed Out]		When this setting is ON, the orientation of the map is automatically changed to North Up when the widest map scale is selected.

SETTING INFORMATION ON MAP

Some information on the map can be displayed or hidden.

Displaying map icons

Displays map icons of certain points of interest (such as restaurants, gas stations, etc.) on the map.

1. Push **<MENU>** and touch [Settings].
2. Touch [Navigation].
3. Touch [Map Settings].
4. Touch [Map Icons].
5. Touch the preferred icon. The indicator of the selected icon illuminates.

INFO:

If brand icons are registered in the map data, the brand icons will be displayed on the map instead of the general map icons.

Displaying map scrolling information

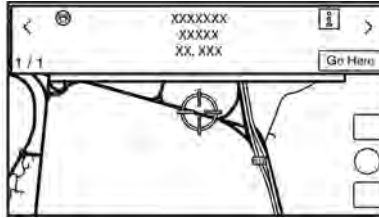

Information about the location on which the center of the cross pointer is placed can be set to be displayed.

1. Push **<MENU>** and touch [Settings].
2. Touch [Navigation] and touch [Map Settings].
3. Touch [Map Scrolling Information].
4. Touch the preferred information item.

The following information items are available.

Availability of the information items varies depending on the models, specifications and software versions.

- [Address Book Icons]
- [Traffic Icons]

- [Destination/Waypoint Icons]
- [Show Pop-Up for POIs]
- [Latitude/Longitude Info]

INFO:

- When the settings are turned on, placing the cross pointer on the icons will display the information in a Pop-Up window.
- The latitude/longitude of any point on the map where the cross pointer is located will be displayed on the bottom left corner of the map screen.
- When the [Go Here] is displayed on the Pop-Up window, the destination can be set by touching it. Touching  will display the place information screen. On the place information screen, touch [Call] to call the selected place if the key is available.
- Touch [**<**] or [**>**] to scroll to the next or previous page.

6. Navigation (if so equipped)

TRAFFIC INFORMATION ON MAP

Traffic information can be displayed on the map.

 "Traffic information on map"
(page 6-42)

SETTING DESTINATION

The system can provide route guidance once a destination is set.

BASIC OPERATIONS

Displaying destination setting menu

There are several methods that can be used to set a destination. Select a preferred method for finding and setting a destination.

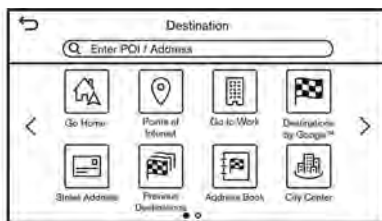

Example

Push **<MENU>** and touch [Destination]/[More Choices...].



INFO:













When a destination is not set yet, some of the destination settings items will be displayed when pushing **<MENU>**.

Availability of the destination setting methods varies depending on models, specifica-



tions and software versions.

6. Navigation (if so equipped)

Available destination setting methods:



Setting item	Action
[Enter POI/Address]	Searches for a destination by inputting the address or POI names.  "Free Text Search" (page 6-17)
[Go Home]	Searches for a route from the current location to the previously stored home location.  "Setting home or work location as destination" (page 6-17)
[Street Address]	Searches for a destination by address.  "Finding address" (page 6-18)
[Points of Interest]	Searches for a destination from various categories.  "Finding points of interest" (page 6-18)
[Previous Destinations]	Searches for the destination from the previous destinations and a previous start point.  "Searching from previous destinations" (page 6-20)
[Go to Work]	Searches for a route from the current location to the previously stored work location.  "Setting home or work location as destination" (page 6-17)
[Address Book]	Searches for a destination from the vehicle Address Book.  "Searching from address book" (page 6-21)
[Destination by Google]	Sets a place searched by Google as a destination.  "Setting destinations by Google™" (page 6-21)
[City Center]	Sets the center of a city as a destination.  "Setting city center" (page 6-22)
[Intersection]	Sets an intersection as a destination.  "Setting intersection" (page 6-22)
[Phone Number]	Searches for a point of interest by a telephone number.  "Setting by phone number" (page 6-23)
[Saved Routes]	Sets a route from the saved route data.  "Setting from saved routes" (page 6-23)

6. Navigation (if so equipped)

[SXM Travel Link]	Sets a destination by using the SiriusXM® Travel Link features.  "Setting with SiriusXM® Travel Link" (page 6-24)
[By Map]	Searches for a destination by map.  "Setting point on map" (page 6-25)
[Latitude/Longitude]	Sets a destination from latitude and longitude.  "Setting with latitude/longitude" (page 6-25)
[Door to Door Navigation]	Turns on/off Door to Door Navigation.



INFO:

- After setting a destination, the location of the destination can be adjusted and the location can be stored in the Address Book, etc.
 "Options before starting the route guidance" (page 6-26)
- The destination can be deleted.
 "Canceling Route" (page 6-33)

Specifying region

With some destination setting methods, state/province and city can be specified prior to searching for destination locations.

1. Push **<MENU>** and touch [Destination]/[More Choices...].
2. Touch the desired search method.
3. Touch [State/Province] or [City] if displayed.
4. Enter the name of the state, province or city and then touch [List]. A list screen is displayed.

5. Touch the preferred state, province or city from the list.



INFO:

- When the system is restarted, the state and province in which the vehicle is recognized by the GPS to be located will be set automatically as a state and province for location search.
- While entering the data, the expected words are displayed on the input screen. The list can be scrolled by touching [**<**] or [**>**].
- Touch [Change Area] to change the area for conducting the location search.
- Touch [Current State] to search for the destination within the state or province where the vehicle is currently located.
- After touching [City], touch [Last 5 Cities] to display the last 5 cities set as destinations.
- In some cases, when a city name has been entered, the number of matching destinations in the "Matches" column may be different from the number displayed on the list screen. If this occurs, enter more characters to further reduce

the number of matches.

- It is not possible to search for a route from the continental United States or Canada to Hawaii, Virgin Islands, Puerto Rico, etc.

FREE TEXT SEARCH

A location or facility can be searched by inputting POI name or Address.

1. Push **<MENU>**.
2. Touch [Enter POI/Address].
3. Enter the POI name or address. After finishing the entry, touch [List]. The search results are displayed in list.



INFO:

- While entering the facility name, the expected selections are displayed on the input screen. The list can be scrolled by touching [**<**] or [**>**].
- The result list can switch between name list and address list by touching [**📍**] or [**🏠**].
- Touching [**ℹ**] will display the place information on the upper display.

4. The following optional functions are available by touching [Option] on the list.
 - [Online]:
When this item is turned on, the system searches for POIs using online information.
 - [Along Route]:
If a route is already set, the system displays only the facilities located along the route.
 - [Near Destination]:
If a route is already set, the system displays only the facilities located near the destination.
 - [Select a City]:
Narrow down the list by specifying the city.
 - [Near Current Location]:
The system displays only the facilities located near the current location.
 - [Sort]:
The list can be sorted by touching [By Distance] or [By Name].
5. Return to the search result screen and touch the preferred destination from the list.

6. The entire route is displayed. Touch [Start] to start route guidance.



INFO:

The Online Search can be used when the TCU (Telematics Control Unit) network connection is available.

SETTING HOME OR WORK LOCATION AS DESTINATION

The home or work location can be quickly set as the destination if the location is stored in advance.

1. Push **<MENU>** and touch [Destination]/[More Choices...].
2. Touch [Go Home] or [Go to Work].



INFO:

- If the home or work location is not stored yet, the system will display a message asking if you wish to store a home or work location. Touch [Yes] to store the home or working place location.
 "Storing home or work location" (page 6-44)

6. Navigation (if so equipped)

- It is also available to set the home as a destination from MENU screen.
 "How to view and operate MENU screen" (page 2-17)
- The entire route is displayed. Touch [Start] to start route guidance.



Voice command

- Push <  > located on the steering wheel.
- After the tone sounds, speak a command.

Use the following voice command to set home or work as the destination:

"Go Home"

"Work"

FINDING ADDRESS

The system supports searching for a destination by address.

- Push <MENU> and touch [Destination]/[More Choices...].
- Touch [Street Address].
- Input the street address.
 - Touch [State/Province] to enter the state or province name.

- Touch [House No. & Street] to enter the house number and the street name. If the house number is not available, touch [No House #].
After finishing the entry, touch [List]. A list of streets is displayed.
- Touch [City] to enter the city name.



INFO:

- While entering the data, the expected words are displayed on the input screen. The list can be scrolled by touching [<] or [>].
 - Touch [Last 5 Cities] to display the last 5 cities set as destinations.
- When information about house number, street, city, and state are entered, the destination is proposed on the upper display. Touch [OK] to start guidance.
 - The entire route is displayed. Touch [Start] to start route guidance.



Voice command

- Push <  > located on the steering wheel.

- After the tone sounds, speak a command.

Use the following voice command to search for a destination by address:

"Street Address" (if so equipped)

FINDING POINTS OF INTEREST

This allows you to find a facility by name or by category. Specify the region and city of the destination to find it more quickly.



NOTE:

Locations and business hours of facilities are subject to change, which may not be reflected in the map data. Double-check this information before you go to an emergency facility to ensure that you can receive the proper support. Otherwise, you may not receive emergency help when you arrive at the destination.

A confirmation message also appears on the navigation screen. Follow the displayed instructions and check the items required.

Searching for a Points of Interest by name

1. Push **<MENU>**.
2. Touch [Points of Interest].
3. Touch [Spell Name]. A character input screen is displayed.



INFO:

When a route is set, touch [Destination]/[More Choices...] on the MENU screen and select [Points of Interest] to select [Spell Name].

"How to view and operate MENU screen" (page 2-17)

4. Enter the name of the destination facility. After finishing the entry, touch [List]. A list screen is displayed.



INFO:

- While entering the facility name, the expected selections are displayed on the input screen. The list can be scrolled by touching [**<**] or [**>**].
- To search for a POI with two or more words, touch [Space] to enter a space between each word.

- The latest information can be obtained by touching [Online], using TCU (Telematics Control Unit) network connection.

The following optional functions are available by touching [Option] on the list.

- [Along Route]:
If a route is already set, the system displays only the facilities located along the route.
 - [Near Destination]:
If a route is already set, the system displays only the facilities located near the destination.
 - [Select a City]:
Narrow down the list by specifying the city.
 - [Near Current Location]:
The system displays only the facilities located near the current location.
 - [Sort]:
The list can be sorted by [By Distance] or [By Name].
5. Touch the preferred destination facility from the list.

6. The entire route is displayed on the upper display. Touch [Start] to start route guidance.



INFO:

After setting a destination, the location of the destination can be adjusted and the location can be saved in the Saved Location, etc.

"Options before starting the route guidance" (page 6-26)



Voice command

1. Push **< >** located on the steering wheel.
2. After the tone sounds, speak a command.

Use the following voice command to search for Points of Interest from a facility name:

"Navigate to" (if so equipped)

Searching Points of Interest by category

1. Push **<MENU>**.
2. Touch [Points of Interest].

6. Navigation (if so equipped)

INFO:

[Point of Interest] can also be accessed from the shortcut menu.

 "Shortcut menu" (page 2-12)

3. Touch [All Categories].
4. Touch the preferred category. The facility list is displayed.

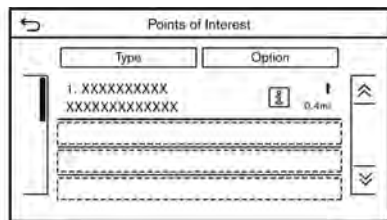

INFO:

If the selected category has subcategories, a list will be displayed. Select the preferred subcategory. Touching [Type] can select the category again after selecting the subcategory.

The POI categories to be used frequently can be registered in the Points of Interest menu.

 "Customizing POIs" (page 6-20)

5. Touch [Option] to narrow down, sort or refresh the list.

 "Free Text Search" (page 6-17)

6. Touch the preferred destination facility from the list.
7. The entire route is displayed on the upper display. Touch [Start] to start route guidance.



Voice command

1. Push <  > located on the steering wheel.
2. After the tone sounds, speak a command.

Use the following voice command to search for Points of Interest from category:

"POI by Category"

Customizing POIs

The POI categories displayed in the Points of Interest menu can be customized.

1. Push <MENU>.
2. Touch [Points of Interest].
3. Touch [Customize POIs].
4. Touch the item number to be modified.

5. Touch the preferred POI category. The selected POI category is displayed in the Points of Interest menu.

SEARCHING FROM PREVIOUS DESTINATIONS

A previous destination or a previous start point can be set as the destination.

Up to 100 previous destinations will be automatically stored. If the number of previous destinations exceeds 100, the oldest one is automatically deleted and the new destination is added.

1. Push <MENU>.
2. Touch [Destination]/[More Choices...].
3. Touch [Previous Destinations]. A list screen is displayed.
4. Touch the previous destination or a previous start point from the list.
5. The entire route is displayed on the upper display. Touch [Start] to start route guidance.



Voice command

1. Push <  > located on the steering wheel.

2. After the tone sounds, speak a command.

Use the following voice commands to display the previous destinations/start point list:

"Previous Destinations"

SEARCHING FROM ADDRESS BOOK

Locations frequently visited can be stored in the Address Book and reused to set destinations.

 "Storing location" (page 6-44)

1. Push **<MENU>**.
2. Touch [Destination]/[More Choices...].
3. Touch [Address Book].

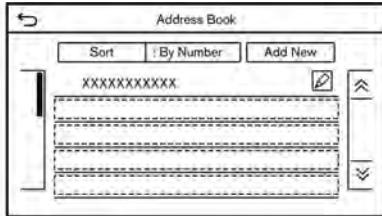



Example

4. Touch the preferred location from the list.



INFO:

- Touch [Add New] to add a new location.
- Touch  to edit the saved route.
 "Editing stored location" (page 6-47)
- Selecting [Sort] displays a list of various sort functions.
 - [Sort by Number]:
The Address Book entries are displayed in ascending numerical order.
 - [Sort by Name]:
The Address Book entries are displayed in alphabetic order.
 - [Sort by Icon]:
By selecting a particular icon, a list that contains only the Address Book entries associated with that icon is displayed.
 - [Sort by Group]:
By selecting a particular group (family, friends, leisure, etc.), the selected group is displayed at the top of the list.
- 5. The entire route is displayed on the upper display. Touch [Start] to start route guidance.



Voice command

1. Push **<MIC>** located on the steering wheel.
2. After the tone sounds, speak a command.

Use the following voice command to set a destination from the Address Book:

"Address Book"

SETTING DESTINATIONS BY GOOGLE™

It is possible to set a destination by downloading the place information searched by Google by entering keywords.

1. Push **<MENU>**.
2. Touch [Destination]/[More Choices...].
3. Touch [Destinations by Google]. A list of search conditions is displayed.
4. Enter the keywords and then touch [List]. A list of the searched items downloaded from Google is displayed.
5. Touch the preferred destination in the list.
6. The entire route is displayed. Touch [Start] to start route guidance.

6. Navigation (if so equipped)



INFO:

The system downloads the information searched by Google via the TCU (Telematics Control Unit). Use of INFINITI InTouch™ Services is dependent upon a valid subscription and the telematics device being in operative condition, as well as cellular connectivity, navigation map data and GPS satellite signal reception being available.

SETTING CITY CENTER

It is possible to set the center of a specified city as a destination.

1. Push <MENU>.
2. Touch [Destination]/[More Choices...].
3. Touch [City Center]. A character input screen is displayed.
4. Enter the name of the city and touch [List]. A list screen is displayed.



INFO:

- While entering the data, the expected words are displayed on the input screen. The list can be scrolled by touching [<] or [>].
- Touch [Last 5 Cities] to display the last 5 cities recently set as destinations.

5. Touch the preferred destination from the list.
6. The entire route is displayed on the upper display. Touch [Start] to start route guidance.



Voice command

1. Push < > located on the steering wheel.
2. After the tone sounds, speak a command.

Use the following voice command to set city center as a destination:

"City Center"

SETTING WITH INFINITI IN-TOUCH™ SERVICES (if so equipped)

It is possible to set the destination using the INFINITI InTouch™ Services features.

"INFINITI InTouch™ Services"
(page 5-7)



INFO:

Use of INFINITI InTouch™ Services features is dependent upon a valid subscription and the telematics device being in operative

condition, as well as cellular connectivity, navigation map data and GPS satellite signal reception being available.

Setting from history

If the downloaded INFINITI InTouch™ Services information feed has location data, you can set it as a destination.

"History" (page 5-12)

1. Push <MENU> and touch [Information].
2. Touch [InTouch Services].
3. Touch [History]. A list screen is displayed.
4. Touch a preferred information feed.

SETTING INTERSECTION

It is possible to set an intersection of any two streets as the destination and have the system calculate a route.

1. Push <MENU>.
2. Touch [Destination]/[More Choices...].
3. Touch [Intersection]. The Intersection screen is displayed.
4. Input the Intersection.
 - Touch [State/Province] to enter the state or province name if necessary.

6. Navigation (if so equipped)

- Touch [City] to enter the city name.
 - Touch [1st Street] to enter the first street name. After finishing the entry, touch [List]. A list screen is displayed. Select the desired street name.
 - After the first street information is entered, touch [2nd Street] to enter the second street name. After finishing the entry, touch [List]. A list screen is displayed. Select the desired street name.
5. Touch [OK].
 6. The entire route is displayed on the upper display. Touch [Start] to start route guidance.



Voice command

1. Push < > located on the steering wheel.
2. After the tone sounds, speak a command.

Use the following voice command to set an intersection as a destination:

"Intersection" (if so equipped)

SETTING BY PHONE NUMBER

If the phone number of a facility is registered in the map data, it is possible to search for a facility by entering the phone number.



INFO:

- If the area code of the specified telephone number does not exist in the map data, the system cannot search for the location.
 - Only the locations included in the database in the map data can be searched for by phone number. Residential phone numbers cannot be used to search for a location.
1. Push <MENU>.
 2. Touch [Destination]/[More Choices...].
 3. Touch [Phone Number]. The telephone number input screen is displayed.
 4. Enter the telephone number including the area code. After finishing entry, touch [OK].
 5. The entire route is displayed on the upper display. Touch [Start] to start route guidance.



INFO:

If there are more than one location registered for the phone number, a list screen is displayed. Touch an item on the list to select a preferred location.

SETTING FROM SAVED ROUTES

It is possible to select a preferred route from the saved routes.

1. Push <MENU>.
2. Touch [Destination]/[More Choices...].
3. Touch [Saved Routes]. A list screen is displayed.
4. Touch the preferred route from the list.

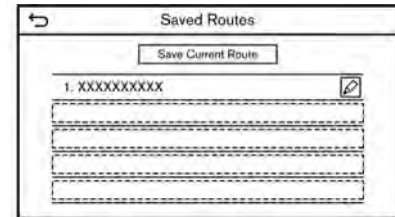

5. The entire route is displayed. Touch [Start] to start route guidance.

6. Navigation (if so equipped)



INFO:

- Touch [✎] to edit the saved route.
👉 "Editing stored route" (page 6-50)
- The saved route only includes locations (destination and waypoints) and route calculation conditions, not the route itself. Therefore, when the destination is set using a saved route, a different route may be suggested if the current vehicle location is different from the one when the route was saved.
- To save the current route, touch [Save Current Route]. A route can be saved only when it includes one or more waypoints.
👉 "Storing route" (page 6-45)

SETTING WITH SIRIUSXM® TRAVEL LINK

It is possible to set the destination using the features of SiriusXM® Travel Link.

👉 "SiriusXM® Travel Link" (page 5-15)



INFO:

A SiriusXM® Travel Link subscription is necessary to receive SiriusXM® information services.

Using SiriusXM® Fuel Prices

Set the preferred gas station as the destination using SiriusXM® Fuel Prices.

1. Push **<MENU>**.
2. Touch [Destination]/[More Choices...].
3. Touch [SXM Travel Link].
4. Touch [SXM Fuel Prices].
5. Touch the preferred gas station from the list.

Available lists:

[Favorite]:

Displays the gas station saved as the favorite.

[Nearby]:

Displays the gas station near the current location.

[Near Dest.]:

Displays the gas station near the destination.

6. Touch [Go Here].
7. The entire route is displayed on the upper display. Touch [Start] on the lower display to start route guidance.

Using SiriusXM® Parking

Set the preferred parking location as the destination using SiriusXM® Parking.

1. Push **<MENU>**.
2. Touch [Destination]/[More Choices...].
3. Touch [SXM Travel Link].
4. Touch [SXM Parking].
5. Touch the preferred parking location from the list.

Available lists:

[Favorite]:

Displays the parking location saved as a favorite.

[Nearby]:

Displays the parking location near the current location.

[Near Dest.]:

Displays the parking location near the destination.

6. Touch [Go Here].
7. The entire route is displayed on the upper display. Touch [Start] to start route guidance.

Using SiriusXM® Movie Listings

Set the preferred theater as the destination using SiriusXM® Movie Listings.

1. Push **<MENU>**.
2. Touch [Destination]/[More Choices...].
3. Touch [SXM Travel Link].
4. Touch [SXM Movie Listings].
5. Search for the theater by the following methods.

[Favorite Theaters]:

Select from the list of theaters which have been saved as favorites.

[Nearby Theaters]:

Select from the list of theaters near the current location.

[Current Movies]:

Select from the list of current movies and [Theaters]. Select the preferred theater from the list to set as a destination.

[Search for a Theater]:

Search for the theater by inputting the name directly.

[Search for a Movie]:

Search for the movie by inputting the title directly.

6. Touch the preferred theater from the list.
7. Touch [Go Here].
8. The entire route is displayed on the upper display. Touch [Start] to start route guidance.

SETTING POINT ON MAP

It is possible to set a location scrolled to on the map as the destination and have the system calculate a route.

1. Push **<MENU>**.
2. Touch [Destination]/[More Choices...].
3. Touch [By Map].
4. Scroll the map on the upper display, place the cross pointer over the preferred location, and touch [OK].



INFO:

The point on the highlighted road where the center of the cross pointer is located can be set as a destination.

5. The entire route is displayed on the upper display. Touch [Start] to start route guidance.

Other settings

1. Scroll the map, place the cross pointer over the preferred location, and display the shortcut menu.
☞ "Shortcut menu" (page 2-12)
2. Touch [New Destination].
3. The entire route is shown on the upper display. Touch [Start] to start route guidance.

SETTING WITH LATITUDE/ LONGITUDE

A destination can be set by specifying the latitude and longitude of the location.

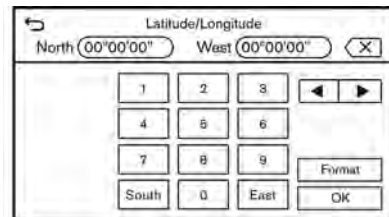

1. Push **<MENU>**.
2. Touch [Destination]/[More Choices...].
3. Touch [Latitude/Longitude]. A number input screen is displayed.

6. Navigation (if so equipped)

4. Enter latitude and longitude of the location to be set as a destination and touch [OK].
5. The location is displayed on the upper display. Touch [OK].
6. The entire route is displayed on the upper display. Touch [Start] to start route guidance.



INFO:

- To switch between entering latitude and longitude, move the cursor by touching [◀] and [▶].
- Touch [Format] to switch the format of the latitude and longitude.
- Touch [West] or [East] to set the appropriate longitude.
- Touch [North] or [South] to set the appropriate latitude.
- A message will appear if the selected location is not included in the map area.

OPTIONS BEFORE STARTING THE ROUTE GUIDANCE

Before starting the route guidance, select menus for route details to modify the route, preview the turn list, or store the route.

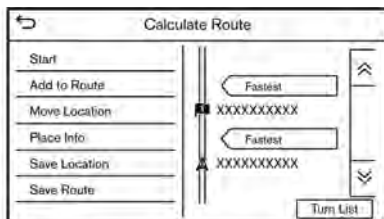

Lower display with waypoint

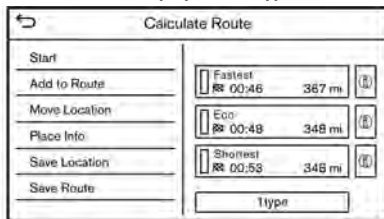

Lower display without waypoint



- [Start]: Starts route guidance to the selected destination.
- [Add to Route]: Adds a location to the route previously

set.

- [Move Location]: The location of the destination or waypoint can be adjusted by moving the cross pointer across the map on the upper display.
- [Place Info]: Displays detailed information of the destination. Touch [Go Here] to set the destination. Touch [Call] (when available) to make a phone call to the facility set as a destination.
- Available route conditions:
 - Suggests alternative routes.
 - [Fastest] Selects a route that is fastest in time.
 - [Eco] Selects a route for the energy saving.
 - [Shortest] Selects a route that is the shortest in distance.
- [Turn List]: Displays a detailed turn list. The map can be displayed and the turn can be avoided by touching a turning point.
 "Displaying Turn List" (page 6-33)

- [Save Location]:
Saves the location to the Address Book.
- [Save Route]:
Store the route for later use.

INFO:

- The entire route on the upper display and the turn list on the lower display will be shown by touching .
- Touch [1type] to display alternative routes calculated with a route search condition selected on the [Basic Route Type] setting screen.
 "Route Preference" (page 6-34)
- Touch [3types] to display alternative routes calculated in all three route search conditions ([Fastest], [Eco] and [Shortest]).
- If you set the destination on the upper display, menus for route detail may be displayed on the upper display.

ROUTE GUIDANCE

ABOUT ROUTE GUIDANCE

After setting the route, select [Start] to start the route guidance.

During route guidance, the system navigates you through the guide points using visual and voice guidance.



WARNING

- **The navigation system's visual and voice guidance is for reference purposes only. The contents of the guidance may be inappropriate depending on the situation.**
- **Follow all traffic regulations when driving along the suggested route (e.g., one-way traffic).**
 "Route guidance" (page 6-58)

Voice guidance during route guidance

Basics of voice guidance:

Voice guidance announces which direction to turn when approaching an intersection for which a turn is necessary.



INFO:

- There may be some cases in which voice guidance and actual road conditions do not correspond. This may occur because of discrepancies between the actual road and the information on the map data, or may also be due to the vehicle speed.
- In case voice guidance does not correspond to the actual road conditions, follow the information obtained from traffic signs or notices on the road.
- Route guidance provided by the navigation system does not take carpool lane driving into consideration, especially when carpool lanes are separated from other road lanes.
- The system will announce street names when the system language is set to English. Street names are not announced when the system is set to French or Spanish.
- When approaching a guide point (intersection or corner) or destination/way-point during route guidance, voice guidance announces the remaining distance and/or turning direction. Push and hold **<MAP/VOICE>** on the INFINITI

6. Navigation (if so equipped)

controller to repeat voice guidance.

Example of voice guidance:

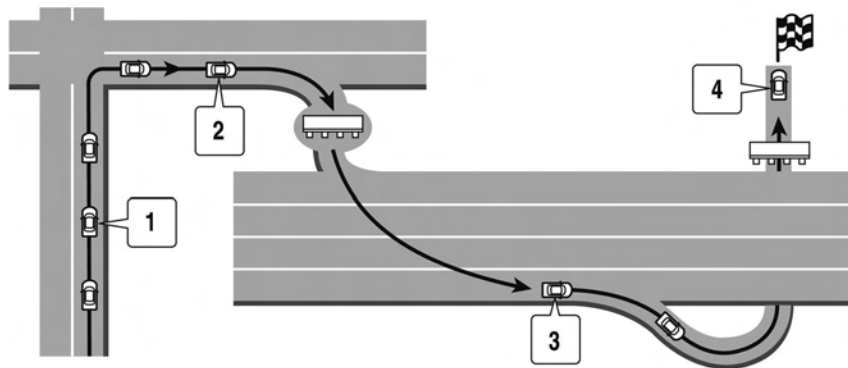

- ① "In about one quarter mile (400 meters), right (left) turn ahead."
"Right (left) turn ahead."
- ② "In about one quarter mile (400 meters) freeway entrance on your right onto (road number and direction)."
"Freeway entrance on your right onto (road number and direction)."

- ③ "In about 1 mile (1.6 kilometers), exit on your right."
"Take the second exit on your right."
- ④ "You have reached your destination. Ending route guidance."

Directions will differ, depending on the road type.

INFO:

Distances may vary, depending on the vehicle speed.

Route guidance screens

Various guidance screens are displayed on the upper display during route guidance.

The settings of the guidance screens can be changed.

 "Map settings" (page 6-9)

Route guidance on map screen:

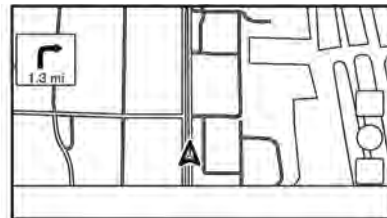

When route guidance starts, the small turn arrow and the distance to the next guide point are displayed in the upper left corner of the map screen. This arrow indicates the turning direction at the next guide point (corner or intersection). When approaching a guide point, an enlarged intersection view is displayed. Also, there may be cases where

6. Navigation (if so equipped)

next street names are announced.

Enlarged intersection view:

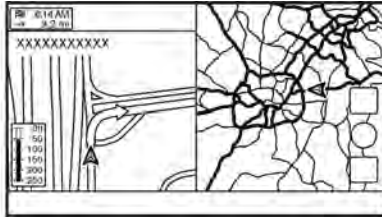

When approaching a guide point, the system automatically changes to the split screen view and shows an enlarged view of the intersection on the left side of the screen. The distance to the guide point and the name of the next street to drive on are displayed at the top of the screen.

Junction guidance:

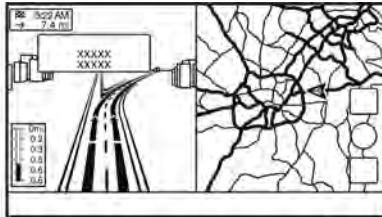

While driving on a freeway, when the vehicle approaches a junction, the system automatically switches to the split screen view and displays an enlarged view of the junction on the left side of the screen.

Turn list:

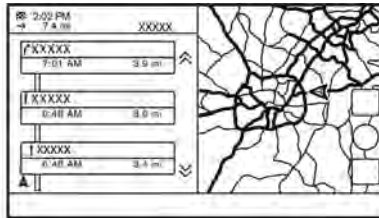

When [Turn List] is selected in the display view bar, a turn list can be displayed on the left side of the screen.

☞ "Changing display view" (page 2-14)

The left screen automatically switches to an enlarged view of the intersection when approaching a guide point.

With [Auto. Show Turn List on Freeway] turned on, the turn list will appear automatically when driving on freeways.

☞ "Map settings" (page 6-9)

Selecting a waypoint from the exit information list:

When exit information is displayed on the turn list, a facility located near the freeway exit can be set as a waypoint. The facility categories that are not shown with an icon on the turn list cannot be selected.

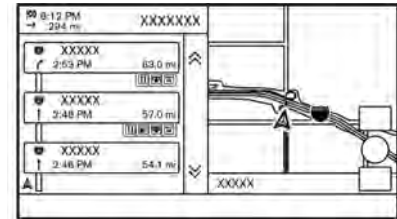

1. Touch the exit where the exit information icon is displayed. The category list screen is displayed.
2. Touch the POI category. A list of facilities located near the freeway exit is displayed.
3. Touch the preferred facility for the waypoint.
4. The waypoint is set, and the route search is performed.
☞ "Options before starting the route guidance" (page 6-26)

6. Navigation (if so equipped)

5. Touch [Start] to start the route guidance.

ROUTE OPTIONS MENU



WARNING

Always stop the vehicle in a safe location before modifying the route conditions. Modifying the route conditions while driving may cause an accident.



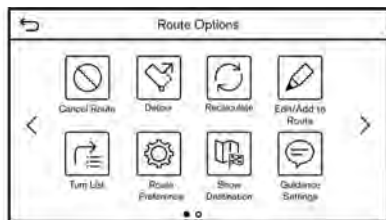



During route guidance, the route conditions can be modified and the route information can be confirmed. Set route conditions according to your personal preference.



Push **<MENU>** when a destination is set, and then touch [Route Options].

The route options menu screen is displayed.

Available items

Menu item		Result
[Cancel Route]		<p>Cancels the current route guidance.</p> <p> "Canceling Route" (page 6-33)</p>
[Turn List]		<p>Displays the turn list.</p> <p> "Displaying Turn List " (page 6-33)</p>
[Detour]		<p>A detour of a specified distance can be calculated.</p> <p> "Setting detour route" (page 6-33)</p>
[Route Preference]		<p>Set the route search conditions.</p> <p> "Route Preference" (page 6-34)</p>
[Recalculate]		<p>Manually search for the route again after changing the search conditions, etc. and have the system calculate a route.</p> <p> "Recalculating route" (page 6-36)</p>
[Show Destination]	[Move Location]	<p>Displays a map screen and allows the location of the destination to be adjusted.</p>
	[Nearby POIs]	<p>Search for points of interest near the destination, such as restaurants and gas stations, etc. The location can be set as a waypoint.</p>
	[Save Location]	<p>Save the destination in the Address Book.</p>
[Edit/Add to Route]		<p>A destination or waypoint can be edited/added to a route that has already been set.</p> <p> "Editing route" (page 6-36)</p>
[Guidance Settings]		<p>Various guidance settings can be customized.</p> <p> "Guidance settings" (page 6-39)</p>

6. Navigation (if so equipped)

[Save Route]	The current route (a destination and waypoints) can be saved. A maximum of 10 routes can be saved. The saved routes can easily be recalled for future use. Saved route includes only the location information, not the route itself. Route may vary depending on the traffic information or other conditions.
[Map Scroll]	Displays the current map screen which can be scrolled to confirm the location of the destination, waypoints, route, etc.
[Simulation]	Simulates the route guidance. This function provides a detailed image of the route with voice guidance. The following operations are available: [⏸]: Pauses the simulation. [▶]: Resumes the simulation. [■]: Ends the simulation. [+]/[-]: Increases/decreases the play speed.



INFO:

When a destination is set, [Cancel Route] and [Turn List] will be displayed on the MENU screen.

"How to view and operate MENU screen" (page 2-17)

CANCELING ROUTE

It is possible to delete a destination and all waypoints that have already been set.

1. Push **<MENU>**.
2. Touch [Cancel Route].
3. A confirmation message is displayed. Touch [Yes] to delete the currently set destinations and waypoints.



INFO:

- The deleted destination and waypoints cannot be reactivated.
- [Cancel Route] can also be accessed from the shortcut menu.
☞ "Shortcut menu" (page 2-12)

DISPLAYING TURN LIST

Displays the details of the suggested route.

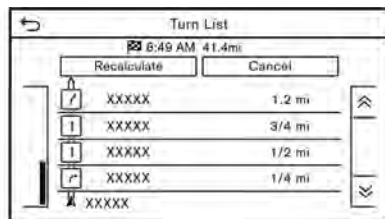

1. Push **<MENU>**.
2. Touch [Turn List].

Setting avoid road

The detour to avoid a road is available by touching the road name on the Turn List display.

1. Touch the road on the list you prefer to avoid. The position of the selected intersection is displayed.
2. Touch [Avoid This Road].
3. Display returns to the turn list. Touch [Recalculate]. The route is recalculated. Touch [Cancel] to cancel the avoid road setting.

SETTING DETOUR ROUTE

To detour from the suggested route, a detour distance can be specified.

1. Push **<MENU>** and then touch [Route Options].
2. Touch [Detour].
3. Touch a detour distance.

Available setting items:

- 1/4 mi (200 m)

- 1/2 mi (500 m)
- 1.0 mi (1.0 km)
- 3.0 mi (5.0 km)
- 5.0 mi (10.0 km)

After calculating the detour, the system displays the detour route on the map.



INFO:

- The detour setting can be canceled by touching [Cancel].
- If the system cannot calculate a detour with the specified conditions, the previous suggested route is displayed.
- If the vehicle is traveling very fast, the detour route may start from a location that the vehicle has already passed.

6. Navigation (if so equipped)

ROUTE PREFERENCE

It is possible to set the conditions of the route search.

1. Push <MENU> and touch [Settings].
2. Touch [Navigation] and touch [Route Preference].
3. Touch the item you would like to set.

Available setting items may vary depending on models, specifications and software versions.

Available setting items

Setting Item		Action	
[Basic Route Type]	[Fastest Route]	Prioritizes the use of fastest route.	
	[Energy-Saving]	Prioritizes a route which uses less energy.	
	[Shortest Distance]	Prioritizes the shortest route. The route may not be the shortest because the system prioritizes roads that are easy to drive on for safety reasons.	
[Other Routing Choices]	[Minimize Freeway]	Minimizes the use of freeways.	
	[Minimize Toll Roads]	Minimizes the use of toll roads.	
	[Time Restricted Roads]	[Follow Restrictions]	Calculates route taking time restriction information into consideration.
		[Ignore Restrictions]	Calculates route without taking time restriction information into consideration.
		[Never Use]	Calculates route avoiding the use of time restricted roads.
	[Seasonal Restrict. Roads]	[Follow Restrictions]	Calculates route taking seasonal restriction information into consideration.
[Ignore Restrictions]		Calculates route without taking seasonal restriction information into consideration.	

6. Navigation (if so equipped)

		[Never Use]	Calculates route avoiding the use of seasonal restricted roads.
	[Use Traffic Information]	[Auto]	Calculates the route automatically taking traffic information into consideration.
		[Accept]	If a traffic jam or incident occurs, a confirmation screen will appear before calculation.
		[OFF]	Calculates the route without taking traffic information into consideration.
	[Use Avoid Area Settings]		When enabled, the system avoids the previously defined avoid areas.
	[Use Ferries]		Includes the use of ferries.
	[Use Car-Carrying Trains]		Includes the use of car-carrying trains.
	[Use Unpaved Roads]		Includes the use of unpaved roads.
	[Use HOV Lanes]		Includes the use of HOV lanes.
	[Use Learned Routes]		Uses the roads that are most frequently traveled with the help of self-learning technology.
[Customize More Routes]	[3types]		Calculates 3 types of route when confirming other routes.
	[1type]		Calculates an alternative route when confirming other routes.
[Estimated Time]	[Destination]		Displays the estimated time of arrival or remaining time to the destination during route guidance.
	[Waypoint]		Displays the estimated time of arrival or remaining time to the waypoint during the route guidance.
[Time Shown on Map]	[ETA]		Displays the estimated time of arrival.
	[Remaining]		Displays the remaining time to arrive.

6. Navigation (if so equipped)

INFO:

- If the vehicle greatly deviates from the suggested route, the system calculates a new route.
- Traffic jam information displayed on the map screen is not statistical traffic information.
- If [Ignore Restrictions] is selected for [Time Restricted Roads] setting, the system calculates a route without any consideration of the regulations concerning the time or day of the week. Therefore, the suggested route may include a road subject to traffic regulations concerning the time or day of the week. When driving along the route, always follow all traffic regulations regardless of whether [Time Restricted Roads] is set to be considered or not.
- Even when [Use Traffic Information] is turned on, if traffic information has not been provided for the area, a detour may not always be indicated in a location where a traffic jam occurs.
- The system calculates to reduce the time required for the entire route from the start to the destination. If there are no appropriate routes, the system may lead to a route where a traffic jam occurs instead of leading to a detour.
- The system may not lead to a detour if the traffic closure or a traffic jam occurs far from the present location.

RECALCULATING ROUTE

A route can be manually searched again after changing the search conditions, etc.

1. Push **<MENU>** and then touch [Route Options].
2. Touch [Recalculate]. A message is displayed and the route is recalculated.
3. Touch [Start] or conduct other operations as necessary.
 "Options before starting the route guidance" (page 6-26)

INFO:

- When a waypoint has been set on the route, the system will search for only one route, even if route recalculation is performed.
- When the vehicle deviates from the suggested route, the route from the current location to the destination is automatically searched again by the auto reroute function.

EDITING ROUTE

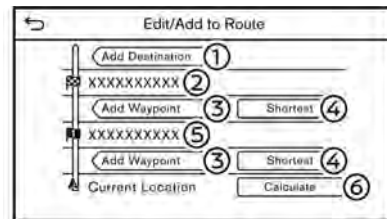

1. Push **<MENU>** and then touch [Route Options].
2. Touch [Edit/Add to Route].
3. Edit the following settings and touch [Calculate].

Available setting items

- ① [Add Destination]:
Touch to add a new destination.
- ② Current destination:
Touch to edit or delete the destination.
☞ "Editing/deleting destination or waypoint" (page 6-37)
- ③ [Add Waypoint]:
Touch to add a waypoint.
☞ "Setting destination or waypoint" (page 6-37)
- ④ Criteria for calculating a route to the destination/waypoint:
Touch to change the conditions for route calculation.
☞ "Changing route calculation conditions" (page 6-38)
- ⑤ Current waypoint:
Touch to edit or delete the waypoint.
☞ "Editing/deleting destination or waypoint" (page 6-37)
- ⑥ [Calculate]:
After editing the route, touch to recalculate a route with new conditions.

Setting destination or waypoint

A destination or waypoint can be added to a route that has already been set.

1. Push **<MENU>** and then touch [Route Options].
2. Touch [Edit/Add to Route].

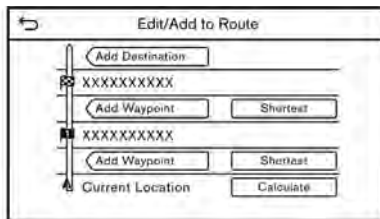

3. Touch [Add Destination] or [Add Waypoint].

INFO:

If [Add Destination] is selected, the current destination changes to a waypoint.

4. Set a destination or waypoint. The method of searching for a destination or waypoint is the same as the one for a destination.
☞ "Setting destination" (page 6-14)

5. Touch [Add to Route] to add the location to the route.
6. The route information with the selected location added to the route is displayed. Adjust the route calculation conditions as necessary.
☞ "Changing route calculation conditions" (page 6-38)
7. Touch [Calculate] to confirm the route change. The route will be recalculated.

INFO:

- The prior route will be deleted automatically.
- Destination or waypoint can also be added from the shortcut menu.
☞ "Shortcut menu" (page 2-12)

Editing/deleting destination or waypoint

A destination or waypoint that has already been set can be modified or deleted.

1. Push **<MENU>** and then touch [Route Options].
2. Touch [Edit/Add to Route].

6. Navigation (if so equipped)

3. Touch a destination or waypoint that is already set.
4. Touch to edit the following settings:

Available setting items

- [Delete]:
A selected destination or waypoint that has already been set can be deleted.
 - [Change Order]:
The order of a destination and waypoints that are already set can be changed.
 - [Move Destination]:
The location of the destination or waypoint can be adjusted by moving the cross pointer across the map on the touch screen display.
5. Touch [Calculate] to apply the change.



INFO:

If the destination is deleted, the route guidance will be canceled.

Changing route calculation conditions

Each section of the route between waypoints can have different route calculation conditions.

1. Push **<MENU>** and then touch [Route Options].
2. Touch [Edit/Add to Route].
3. Touch the route condition shown on the preferred section of the route to the destination or waypoint.
4. Touch the preferred condition.

Available setting items

- [Fastest Route]:
Prioritizes the use of fastest route.
 - [Energy-Saving]:
Prioritizes a route which uses less energy.
 - [Shortest Distance]:
Prioritizes the shortest route. The route may not be the shortest because the system prioritizes roads that are easy to drive on for safety reasons.
5. The conditions are changed. Touch [↵] to return to the edit route screen.

6. Touch [Calculate] to apply the change.



INFO:

The recalculated route may not be the shortest route because the system prioritizes roads that are easy to drive on for safety reasons.

Changing order of destination and waypoints

The order of a destination and waypoints that are already set can be changed.

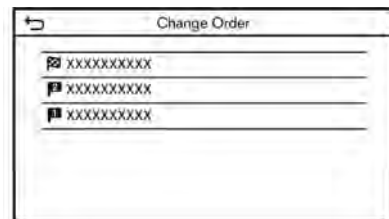

1. Push **<MENU>** and then touch [Route Options].
2. Touch [Edit/Add to Route].
3. Touch a destination or waypoint that is already set.
4. Touch [Change Order].

5. Touch a preferred destination or waypoint to replace the previously selected destination or waypoint.
6. Touch [Calculate] to apply the change.

GUIDANCE SETTINGS

Various settings are available to customize the guidance information provided by the system.

1. Push <MENU> and touch [Settings].
2. Touch [Navigation] and touch [Guidance Settings].
3. Touch an item you would like to set.

Available items may vary depending on models, specifications and software versions.

Setting item	Action
[Guidance Volume]	Adjusts the volume level of voice guidance.
[Guidance Voice]	Activates or deactivates voice guidance.
[Traffic Announcement]	Activates or deactivates the traffic announcement. When this item is activated, the system provides an announcement of traffic information or events on the route. The indicator illuminates if traffic announcement is activated.
[Toll Booth Guide]	Activates or deactivates the function to notify that the vehicle is approaching a toll booth.



INFO:

- [Guidance Settings] can also be accessed from the route options screen.
☞ "Route options menu" (page 6-30)
- The guidance volume can also be adjusted by turning <VOL/ > or pushing <- +> on the steering wheel while voice guidance is being announced.

6. Navigation (if so equipped)

VIEWING TRAFFIC INFORMATION

Two types of traffic information are available on this system, SiriusXM Traffic™ Information and Premium Traffic Information.

To activate SiriusXM Traffic™ Information, set [Use Premium Traffic] off.

To activate Premium Traffic Information, set [Use Premium Traffic] on.

 "Traffic information setting"
(page 6-43)

SiriusXM TRAFFIC™ (if so equipped)

SiriusXM Traffic™ information is a subscription service offered by SiriusXM® Radio.

This service provides real-time information regarding traffic flow, accidents, road construction and other incidents, where available.

SiriusXM Traffic™ combines information from commercial and public traffic data providers including government departments of transportation, police, emergency services, road sensors, cameras and aircraft reports. The traffic information is broadcast

to the vehicle by the SiriusXM® satellites. Available traffic information on the route the driver selected is shown on the navigation screen so traffic conditions between you and the destination are known. Three types of real-time traffic information for major roadways are shown on the navigation system:

* Unscheduled traffic data, for example, accidents and disabled vehicles.

* Scheduled traffic data, for example, road construction and road closures.

* Traffic flow information (rate of speed data).



WARNING

SiriusXM Traffic™ information is not a substitute for attentive driving. Traffic conditions change constantly and emergency situations can arise without warning. Relying only on SiriusXM Traffic™ information may lead to a collision and could result in serious personal injury.



NOTE:

- Turn [Use Premium Traffic] off when receiving SiriusXM Traffic™ information.
 "Traffic information setting"
(page 6-43)
- Flow information is provided only for roads equipped with traffic sensors and is not available in all markets covered by the service. Flow data may not be available on portions of a road that is under construction.
- A SiriusXM Traffic™ subscription is necessary to view Traffic Info.

Notes on SiriusXM Traffic™ information

- The SiriusXM Traffic™ information service is not provided for some cities. In addition, the cities for which the traffic information service is provided may be changed.
- In some cases, infrastructure problems may prevent the complete display of the traffic information. This is not a malfunction.

6. Navigation (if so equipped)

- Depending on the traffic information, a detour route may be slower than the original route.
- SiriusXM® Radio and SiriusXM Traffic™ subscriptions are sold separately or as a package, and are continuous until you call SiriusXM® to cancel. See SiriusXM® Customer Agreement for complete terms at the SiriusXM® website.

SiriusXM® website:

For U.S.

www.siriusxm.com

For Canada

www.siriusxm.ca (English)

www.siriusxm.ca/fr (French)

- SiriusXM® Travel Link is available in select markets. For more information, refer to the SiriusXM® website or call Listener Care.

SiriusXM® website:

For U.S.

www.siriusxm.com/infotainment

For Canada

<https://www.siriusxm.ca/siriusxm-infotainment> (English)

<https://www.siriusxm.ca/fr/siriusxm-infodivertissement> (French)

Listener Care:

For U.S.

1-877-447-0011

For Canada

1-877-438-9677

- SiriusXM Traffic™ is available in over 130 metropolitan markets. For the most current list of markets covered, please refer to the SiriusXM® website or call Listener Care.

SiriusXM® website:

For U.S.

www.siriusxm.com/infotainment

For Canada

<https://www.siriusxm.ca/siriusxm-infotainment> (English)

<https://www.siriusxm.ca/fr/siriusxm-infodivertissement> (French)

Listener Care:

For U.S.

1-877-447-0011

For Canada

1-877-438-9677

- Due to road maintenance, infrastructure problems (e.g. malfunction of road sensors, outage of central computer of infrastructure) or natural disasters, there are times when some or all traffic information may not be available.
- Incident information is based on human collection. Not all incidents that have happened are collected and provided.
- Due to the coverage and quality of traffic information and road conditions, it is not always possible for the system to provide the shortest time route even when traffic information is considered.
- Traffic information that is displayed may differ from information from other media (e.g., radio), as other media may use different information sources.

PREMIUM TRAFFIC INFORMATION

Real-time traffic information can also be obtained from Premium Traffic information with more street coverage using the TCU (Telematics Control Unit) installed in your vehicle.

The types of event displayed on the screen are the same as SiriusXM Traffic™ Informa-

6. Navigation (if so equipped)

tion.

Premium Traffic information is available by turning [Use Premium Traffic] on.

☞ "Traffic information setting"
(page 6-43)

VIEWING AVAILABLE TRAFFIC INFORMATION

Viewing traffic events from list

1. Push **<MENU>** and then touch [Information].
2. Touch [SXM Traffic] or [Premium Traffic]. A list of available types of information is displayed.

Available items	Function
[Show the Traffic on the Route]	Displays a list of traffic information found on the route from the current vehicle location to the destination. Available only when a route is set.
[Nearby Traffic Info]	Displays a list of available traffic information around the current vehicle location.



INFO:

[SXM Traffic] or [Premium Traffic] is available only when the traffic information is received.

3. Touch the preferred item. A list of available events are displayed.

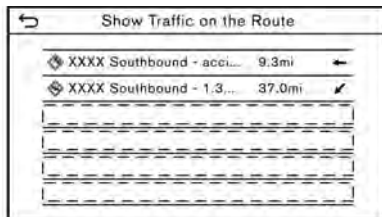

4. Touch an event from the list to check the detailed information and the map. Touch [Avoid] to search for an alternate route.

Displaying urgent traffic information

When an urgent event is found around the current vehicle location, a message pops up automatically on the upper display with a voice announcement.

The message includes the icon, event type, event information and the direct distance from the current location to the event.



INFO:

- When there are multiple urgent events, the event with the shortest direct distance from the current location is displayed.
- If the urgent event is on the recommended route, and if a detour is found, the detour route notification screen is displayed when the vehicle approaches the detour point.



Traffic information on map

Traffic information is displayed on both 2D and 3D map screens.

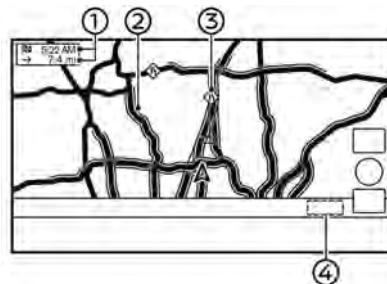
Screen information



Example

- ① Remaining distance and estimated remaining time/time of arrival:
Remaining distance and estimated remaining time to the destination/time of arrival calculated with consideration of traffic information on route is displayed.
Whether to display the remaining time to the destination or estimated arrival time at the destination can be selected.
 "Route Preference" (page 6-34)
- ② Road conditions:
Free Flow: Green
Slow traffic: Yellow
Heavy traffic: Red
Road closed and section affected by serious traffic event: Orange and white stripes
Queuing traffic: Orange (Premium Traffic information only)
- ③ Traffic information icon:
If a route is not already set, all of the traffic information icons on the map screen are displayed in gray. When a route is already set, the icons on the route are displayed in color, and the icons outside the route are displayed in gray.
-  Traffic jam
 -  Slow traffic

-  Traffic flowing freely
-  Road closed
-  Accident
-  Road work
-  Narrow lanes
-  All other events

- ④ Traffic indicator:
SiriusXM Traffic™
Displayed when there is available SiriusXM Traffic™ Information received. A SiriusXM Traffic™ subscription is necessary to view traffic information.
PREMIUM TRAFFIC
Displayed when there is available Premium Traffic Information received.



INFO:

Traffic icons are displayed in the scale level of 1/64 miles (15 m) - 7.5 miles (12.5 km) range. Some traffic icons are displayed only on the map at higher detail levels.

TRAFFIC INFORMATION SETTING

Settings for traffic information related functions can be changed.

1. Push **<MENU>** and touch [Settings].
2. Touch [Navigation].
3. Touch [Traffic Info Settings].
4. Touch the preferred setting. The indicator for the selected setting illuminates.

Available setting items may vary depending on models, specifications and software versions.

Available setting items

- [Use Premium Traffic]:
Turns the Premium Traffic information on/off.
- [Filter Traffic Icons]:
Selects which types of traffic incidents (e.g., accident) will be displayed on the map screen.
- [Premium Traffic Update Settings]:
Sets the update timing of Premium Traffic information.

6. Navigation (if so equipped)

INFO:

Even when [Traffic Announcement] is set to off, the route guidance will not be affected. Also, the announcement of emergency information and weather information will not be turned off.



STORING A LOCATION/ROUTE

STORING LOCATION

Often visited locations can be stored in the Address Book. The stored addresses can be easily retrieved to set them as a destination or waypoint. The Address Book can store up to 200 locations.

Storing home or work location

A home or work location can be stored in the system.

1. Push **<MENU>** and touch [Settings].
2. Touch [Navigation] and touch [Address Book].
3. Touch [Add Home Location] or [Add Work Location].
4. Touch an appropriate method to set the location. Refer to the search methods used for destination setting.
 "Setting destination" (page 6-14)
When stored, the location is displayed at the center of the map on the upper display.
5. Edit the contents of the stored item as necessary and touch [OK].
 "Editing stored location"

(page 6-47)

INFO:

If you touch [Go Home (Save Location)] or [Go to Work (Save Location)] on the destination screen while the home or work location is not stored yet, the system will display a message asking if you wish to store a home or work location. Touch [Yes] to store the home or work location.

Storing location by searching

It is possible to store a location by searching in various ways.

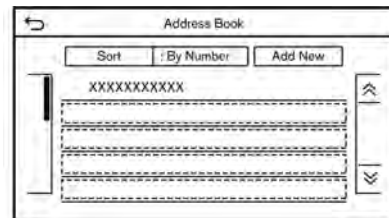

1. Push **<MENU>** and touch [Settings].
2. Touch [Navigation].
3. Touch [Address Book].
4. Touch [Saved Location].

6. Navigation (if so equipped)

5. Touch [Add New].
6. Touch an appropriate method to set a location. Refer to the search methods used for destination setting.
☞ "Setting destination" (page 6-14)
7. Touch [OK].
8. A message is displayed, and the address of the location is stored in the Address Book.
9. Adjust and edit the contents of the stored item as necessary. Touch [OK] to confirm.
☞ "Editing stored location" (page 6-47)



INFO:

- When the location is stored in the Saved Locations, [Address Book] can be used to search for the location.
☞ "Searching from address book" (page 6-21)
- When 200 locations are already stored, a new location cannot be stored until a currently stored location is deleted.

Storing location by moving map

1. Move to the preferred location on the map and display the shortcut menu.
☞ "Shortcut menu" (page 2-12)

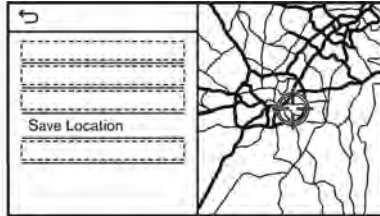

2. Touch [Save Location]. A message is displayed.
3. The icon representing the stored location is displayed on the map. Push **<MAP/VOICE>** on the INFINITI controller to return to the current location map screen.

STORING ROUTE

A maximum of 10 calculated routes can be stored. Stored routes can be easily retrieved and set as the suggested route.

A route requires at least one waypoint in order to be stored.

1. Push **<MENU>** and touch [Route Options].
2. Touch [Save Location] in the shortcut menu. A confirmation message is displayed. Select [Yes] to store the current route.

Other settings

A route can also be stored using the following procedure.

1. Push **<MENU>** and touch [Settings].
2. Touch [Navigation].
3. Touch [Address Book].
4. Touch [Saved Routes].
5. Touch [Save Current Route]. A confirmation message is displayed.
6. Confirm the contents of the message and touch [Yes]. The current route is stored.



INFO:

- At least 1 waypoint must be set for the route to be stored.
- A stored route includes only locations (destination and waypoints) and route calculation conditions, not the route itself.

6. Navigation (if so equipped)

- The route is stored in the first available position number in the stored routes list.
- When 10 routes are already stored in the address book, a new route cannot be stored until a route is deleted.
☞ "Deleting stored item" (page 6-50)

STORING AVOID AREA

An Avoid Area can be stored. The Avoid Area is an area that can be excluded from a route, such as a road that is always congested. Once Avoid Areas are stored, the system avoids those areas when calculating a route. Up to 10 Avoid Areas can be stored.

1. Push **<MENU>** and touch [Settings].
2. Touch [Navigation].
3. Touch [Address Book].
4. Touch [Avoid Area].



5. Touch [Add New].
Touch an appropriate method to search for a location.
☞ "Setting destination" (page 6-14)
6. Touch [OK].
7. Adjust the information of the Avoid Area as necessary.
☞ "Editing avoid area" (page 6-50)
8. Touch [OK] to store the avoid area information.

INFO:

A maximum of 10 Avoid Areas can be stored. When 10 Avoid Areas are already stored, a new Avoid Area cannot be stored until a currently stored Avoid Area is deleted.
☞ "Deleting stored item" (page 6-50)

EDITING STORED INFORMATION



Items stored in the system can be edited.

Editing stored location



1. Push <MENU> and touch [Settings].
2. Touch [Navigation] and touch [Address Book].

Setting item		Action	
[Home Location]*	[Edit]	[Show Icon on Map]	Displays the home icon on the map.
		[Icon]	Selects a home icon of a preferred design.
		[Sound]	Sets the type of the alarm that sounds when the vehicle approaches home.
		[Direction]	Sets the alarm to sound when approaching from a specific direction.
		[Distance]	Sets the alarm to sound when reaching a specific distance to home.
		[Phone No.]	Stores the home telephone number.
	[Move Location]	Adjusts the stored home location.	
	[Delete]	Deletes the stored home location.	
	[OK]	Confirms and saves the edited home information.	
[Work Location]*	[Edit]	[Show Icon on Map]	Displays the work icon on the map.
		[Icon]	Selects a work icon of a preferred design.
		[Sound]	Sets the type of alarm that sounds when the vehicle approaches work.

6. Navigation (if so equipped)

		[Direction]	Sets the alarm to sound when approaching from a specific direction.	
		[Distance]	Sets the alarm to sound when reaching a specific distance to work.	
		[Phone No.]	Stores the work telephone number.	
	[Move Location]		Adjusts the stored work location.	
	[Delete]		Deletes the stored work location.	
	[OK]		Confirms and saves the edited work information.	
[Saved Locations]	[Sort]	[Sort by Number]	Sorts the saved locations.  "Searching from address book" (page 6-21)	
		[Sort by Name]		
		[Sort by Icon]		
		[Sort by Group]		
	[Add New]		Adds a new location.  "Storing location by searching" (page 6-44)	
	Saved Location List	[Edit]	[Show Icon on Map]	Displays the icon of a stored location on the map.
			[Name]	Registers a name of the entry.
			[Voice Tag]	Registers a voice tag for the entry which allows the entry to be used with the Voice Recognition System.
			[Icon]	Selects an icon for the entry.
			[Sound]	Sets the type of the alarm that sounds when the vehicle approaches the location.
[Direction]			Sets the alarm to sound when approaching from a specific direction.	

6. Navigation (if so equipped)

			[Distance]	Sets the alarm to sound when reaching a specific distance to the location.
			[Phone No.]	Registers a phone number for the location.
			[Group]	Registers a group of the entry.
			[Entry Numbers]	Registers an entry number for the location.
		[Move Location]		Adjusts the stored location information.
		[Delete]		Deletes the stored location information.
		[OK]		Confirms and saves the edited stored location information.
[Saved Routes]				Edits the saved routes.  "Editing stored route" (page 6-50)
[Avoid Area]				Edits the avoid area.  "Editing avoid area" (page 6-50)
[Delete Saved Items]				Deletes the saved items.  "Deleting stored item" (page 6-50)

*: When home or work location has not been stored, [Add Home Location] or [Add Work Location] is displayed and a home or work location can be stored from the menu.

6. Navigation (if so equipped)

Editing stored route

1. Push **<MENU>** and touch [Settings].
2. Touch [Navigation] and touch [Address Book].
3. Touch [Saved Routes].
4. Touch the preferred saved route from the list. Saved Routes settings screen will be displayed.

Setting item	Action
[Rename]	Changes the saved route name.
[Replace]	Overwrites the saved route with the current route.
[Delete]	Deletes the saved route.
[OK]	Applies the edited settings.

Editing avoid area

1. Push **<MENU>** and touch [Settings].
2. Touch [Navigation] and touch [Address Book].
3. Touch [Avoid Area].
4. Touch a preferred Avoid Area from the list. Avoid Area settings screen will be displayed.

Setting item	Action
[Rename]	Changes the name of an Avoid Area.
[Move Location]	Adjusts the Avoid Area location.
[Resize Area]	Adjusts the size of the Avoid Area.
[Freeway]	Sets the Avoid Area to include or not include freeways. The color of the Avoid Area changes depending on the setting. Freeway ON: Green Freeway OFF: Blue
[Delete]	Deletes an Avoid Area.
[OK]	Applies the edited setting.

DELETING STORED ITEM

The locations and routes in the Address Book can be deleted. Deleting an individual item and deleting all stored items are available.



INFO:

Deleted items cannot be restored. Before deleting an item, always make sure that the item is no longer needed.

Deleting stored item individually

1. Push <MENU> and touch [Settings].
2. Touch [Navigation] and touch [Address Book].
3. Touch [Delete Saved Items].

Select the preferred item and touch [Yes] to confirm deletion.

Step 1	Step 2	Action
[Delete Home Location]		Deletes home location.
[Delete Work Location]		Deletes work location.
[Delete Address Book]	[Delete All]	Deletes all stored locations.
	[Delete One]	Deletes a selected stored location.
[Delete Saved Routes]	[Delete All]	Deletes all stored routes.
	[Delete One]	Deletes a selected stored route.
[Delete Avoid Areas]	[Delete All]	Deletes all Avoid Areas.
	[Delete One]	Deletes a selected Avoid Area.
[Delete Previous Destinations]	[Delete All Previous Destinations]	Deletes all of the previous destinations.
	[Delete a Previous Destination]	Deletes a selected previous destination.
	[Delete Previous Start Point]	Deletes the previous start point.
[Delete Learned Routes]		Deletes the learned routes.

6. Navigation (if so equipped)

Deleting individual item on map

1. Align the cross pointer over the stored location to be deleted by moving on the map, and then display the shortcut menu.
 "Shortcut menu" (page 2-12)
2. Touch [Delete].
3. A confirmation message is displayed. Confirm the contents of the message and touch [Yes].
The stored item is deleted from the Address Book.

NAVIGATION SETTINGS

The navigation system can be customized according to the user's preference.



1. Push <MENU> and touch [Settings].
2. Touch [Navigation].
3. Touch the item you would like to set.

Available setting items may vary depending on models, specifications and software versions.

Available setting items

Setting item	Result
[Map Settings]	Sets the display method and direction of the map. ☞ "Map settings" (page 6-9)
[Guidance Settings]	Sets the various functions for route guidance. ☞ "Guidance settings" (page 6-39)
[Route Preference]	Changes the routing preferences. ☞ "Route Preference" (page 6-34)
[Traffic Info Settings]	Sets the various functions of the Traffic information feature. ☞ "Traffic information setting" (page 6-43)
[Speed Limit Indication on Map]	Turns on/off the speed limit display function. When this item is turned on, a speed limit indicator will appear on the map screen when available.
[Speed Limit Warning]	Turns on/off the speed limit warning.
[Speed Limit Sensitivity]	Adjusts the speed limit sensitivity. This function is available when [Speed Limit Warning] is turned on.
[Address Book]	Stores locations and routes. Stored items can be edited or deleted. ☞ "Storing a location/route" (page 6-44)
[Customize POIs]	Sets the POI categories to be displayed on the Points of Interest screen. ☞ "Customizing POIs" (page 6-20)

6. Navigation (if so equipped)

Setting item	Result
[Adjust Current Location]	If the vehicle icon indicating the current vehicle location is not in the correct position, the location of the vehicle icon on the map screen can be adjusted.
[Delete Saved Items]	Deletes a saved location or route.  "Deleting stored item individually" (page 6-51)
[Delete Previous Destinations]	Deletes all or one of the previous destinations or the previous start point.  "Deleting stored item individually" (page 6-51)
[Sync with Door to Door Navigation]	Turns on/off Door to Door Navigation.
[Reset All Navigation Settings to Default]	This resets various settings (display, volume level, etc.) to the default settings.

GENERAL INFORMATION FOR NAVIGATION SYSTEM

CURRENT VEHICLE LOCATION

Display of current vehicle location

This navigation system combines the data obtained from the vehicle (by gyro sensor) and from GPS (Global Positioning System) satellites to calculate the current location of the vehicle. This position is then displayed throughout route guidance to a destination.

What is GPS (Global Positioning System)?

GPS is a position detecting system that uses satellites deployed by the U.S. government. This navigation system receives radio signals from three or more different satellites that orbit 13,049 miles (21,000 km) above the earth in space, and detect the position of the vehicle by utilizing the principle of triangulation.

Positioning adjustment:

When the system judges that the vehicle position is not accurate based on vehicle speed and gyro sensor data calculations, the system will automatically adjust the position

of the vehicle icon using GPS signals.

Receiving signals from GPS satellites:

The reception of GPS signals can be weak, depending on the environment. Vehicles in the following areas/environments may not receive GPS signals.

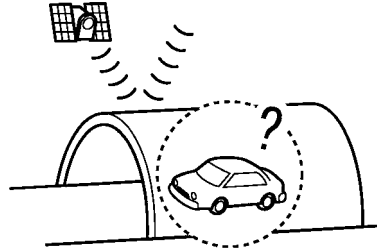

- Inside tunnels or parking garages

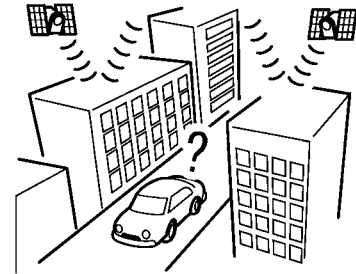

- In areas with numerous tall buildings

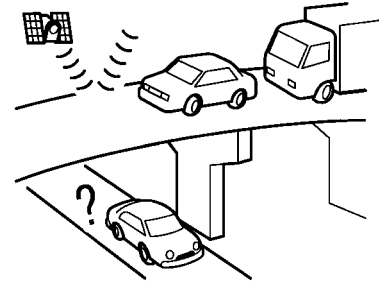

- Under multi-layered highways

6. Navigation (if so equipped)

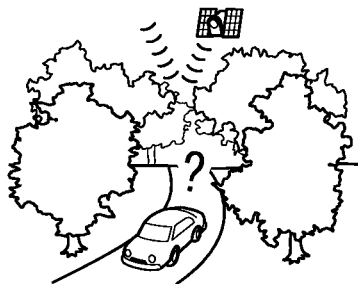

- Areas with numerous tall trees

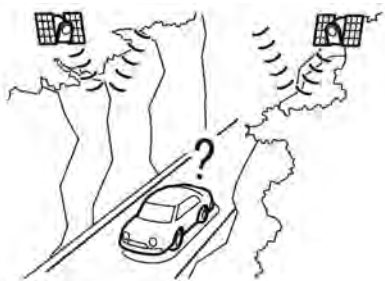

- In canyons

INFO:

The GPS antenna is located on the instrument panel inside the vehicle. Do not place any objects, especially cellular phones or transceivers, on the instrument panel. Because the strength of the GPS signal is approximately one billionth of that of TV waves, phones and transceivers will affect or may totally disrupt the signal.

Incorrect display of vehicle position

The following cases may affect the display accuracy of the vehicle's position or traveling direction. The accuracy will return to normal if the driving conditions return to normal.

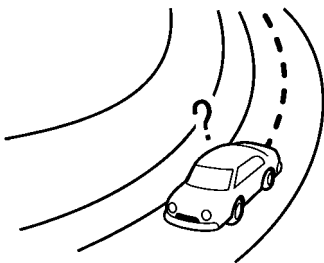

- When there is a similar road nearby.

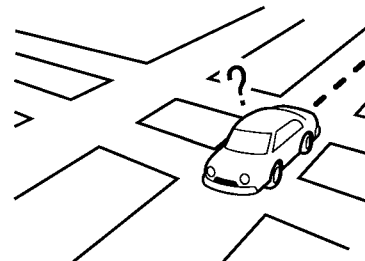

- When the vehicle is traveling in an area with a grid pattern road system.

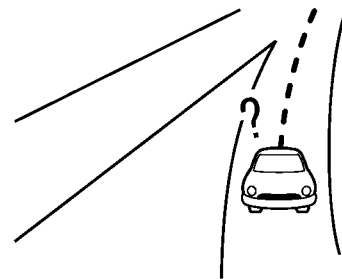

- When the vehicle is passing through a large Y-shaped intersection/junction.

6. Navigation (if so equipped)

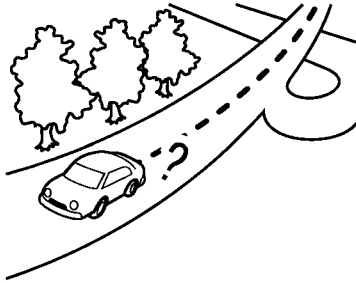

- When the vehicle is traveling on a continuous, slowly curving road.

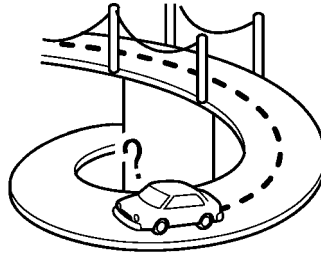

- When the vehicle is on a loop bridge.

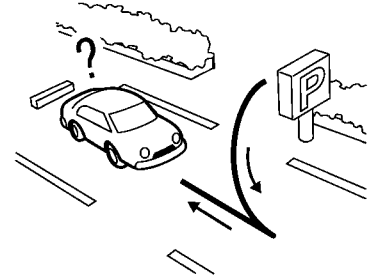

- When repeatedly turning left or right, or driving in zigzags.

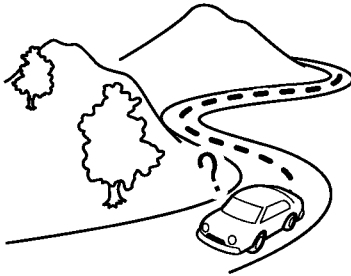

- When the vehicle is traveling on a road with repeating S-shaped curves.



- When the vehicle is on a snow-covered or unpaved road.

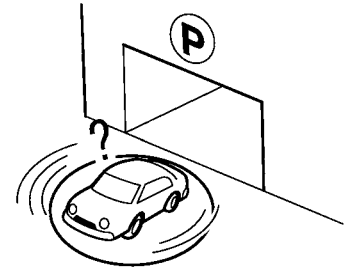

- When the vehicle is rotated on a parking lot turntable while the ignition switch placed in the OFF position.

6. Navigation (if so equipped)

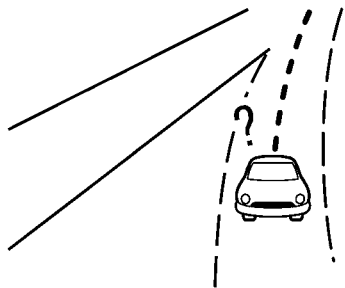

- When driving on a road not displayed on the map screen or a road that has been changed due to additional construction or other reasons.

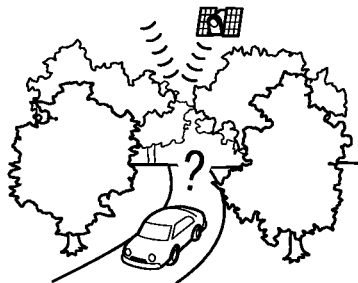

- When the GPS positioning accuracy is low.

INFO:

- The vehicle icon may be misaligned when starting the vehicle just after starting the engine.
- The vehicle icon may also be misaligned if different sized tires or tire chains are installed.
- The system has a function that automatically corrects the vehicle icon position when it is misaligned from the actual position.
- Vehicle position correction by GPS may not function when the vehicle is stopped.
- If the vehicle icon position does not return to normal even after driving for a while, correct the vehicle icon position manually.

Detailed Map Coverage Areas (MCA) for navigation system

This system is designed to help guiding to the destination, and it also performs other functions as outlined in this manual. However, the system must be used safely and properly. Information concerning road conditions, traffic signs and the availability of services may not always be up-to-date. The

system is not a substitute for safe, proper and legal driving.

Map data covers select metropolitan areas.

Map data includes two types of areas: "Detailed coverage areas" providing all detailed road data and other areas showing "Main roads only".

INFO:

Detailed map data is not available in many areas and is generally limited to select major metropolitan areas.

ROUTE GUIDANCE

INFO:



- The system will announce street names when the system language is set to English. Street names are not announced when the system is set to French or Spanish.

Repeating voice guidance

This function is available throughout route guidance, from the time after the route calculation is completed until the vehicle arrives at the destination. Push and hold **<MAP/VOICE>** on the INFINITI controller.

Voice guidance will be repeated.

Notes on voice guidance

- Voice guidance in this system should be regarded as a supplementary function. When driving the vehicle, check the route on the map and follow the actual roads and traffic regulations.
- Voice guidance is activated only for intersections with certain conditions. There may be cases where the vehicle has to turn, but voice guidance is not provided.
- Voice guidance contents may vary, depending on the direction of the turn and the type of intersection.
- The voice guidance timing will vary depending on the situation.
- When the vehicle has deviated from the suggested route, voice guidance is not available. The system will not announce this. Refer to the map and recalculate the route.
 "Recalculating route" (page 6-36)
- Voice guidance may not accurately correspond with road numbers and directions at freeway junctions.
 - Voice guidance may not accurately correspond to street names at freeway exits.
 - The displayed street names may sometimes differ from the actual names.
 - Voice guidance is not available when the [Guidance Voice] is turned off.
 "Volume and Beeps settings" (page 2-31)
 - Voice guidance will start when the vehicle enters the suggested route. Refer to the map for directions to the starting point of the route.
 - When approaching a waypoint, voice guidance will announce, "You have arrived at waypoint 1 (2, 3, 4,...)." Voice guidance will switch to the next section of the route. When voice guidance is not available, refer to the map for directions.
 - In some cases, voice guidance ends before arrival at the destination. Refer to the destination icon on the map to reach the destination.
 - If the system recognizes on which side the destination (waypoint) is located, voice guidance will announce "on the right/left" after announcing the arrival at the destination.
- Voice guidance may be partially operational or inoperative due to the angle of roads at an intersection.
- Because freeway lane information is available only for approximately 7,000 major freeways in North America, it is not possible to display information for all junctions and exits.
- Freeway exit information may differ from the information on the actual exit signs.
- Because it is not possible to consider data concerning roads that are seasonally available or unavailable, a route may be displayed that does not match the actual traffic restrictions. Be sure to follow the actual traffic restrictions while driving.
- Canada and Alaska contain many roads with incomplete map data. As a result, when searching for a route, the route may include roads with incomplete data. In regions where road data is not complete, voice guidance may stop for long periods of time. Be sure to follow the actual traffic restrictions while driving.

6. Navigation (if so equipped)

ROUTE CALCULATION

- The suggested route may not be the shortest, nor are other circumstances such as traffic jams considered.
- Because of the inevitable difference in road conditions and circumstances between the time you use this system and the time the information was produced for the map data, there may be discrepancies in roads and regulations. In such cases, actual road conditions and regulations take precedence over map data information.
- During route calculation, the map will not scroll, however the vehicle icon will move according to the actual vehicle's movement.
- In some cases, after the calculation is complete, the calculated route may not be immediately displayed.
- Waypoints that have been passed will be disregarded by rerouting calculation.
- If you scroll the map while the suggested route is being drawn, it may take more time to finish drawing.
- Route calculation may not be completed in the following cases.
 - If there is no main road within a range of 1.5 miles (2.5 km) from the vehicle, a message saying so will appear on the screen. Try recalculating when the vehicle is closer to a main road.
 - If there is no main road within a range of 1.5 miles (2.5 km) from the destination or waypoint, a message saying so will appear on the screen. Try setting the location closer to a main road.
 - If the vehicle is too close to the destination or if there are no roads to the destination, a message saying so will appear on the screen.
 - If it is impossible to reach the destination or waypoints because of traffic regulations, etc.
 - If the only route to reach the destination or waypoints is extremely complicated.
- The following may occur when the route is displayed.
 - If you calculate a route on a main road, the starting point of the route may not exactly match the current vehicle location.
 - The endpoint of the route may not exactly match the destination.
 - If you calculate a route on a main road, the system may display a route from another main road. This may be because the position of the vehicle icon is not accurate. In this case, park the vehicle in a safe location and reset the vehicle icon, or continue driving to see if the position of the vehicle icon is automatically adjusted before recalculating the route.
 - There are cases in which the system shows an indirect route to reach the destination or waypoints, if you set them from stored or facility information. In order to correct this, you must be careful about the traffic direction, especially when lanes with different travel directions are shown separately, such as interchanges and service areas.
 - This system makes no distinction between limited traffic control and total control (blockage). It may show an indirect route even if the road is usable.

6. Navigation (if so equipped)

- Even if the ferry preference is set to OFF, a route that uses a ferry line may be suggested.

HOW TO UPDATE MAP DATA



WARNING

TO AVOID RISK OF DEATH OR SERIOUS PERSONAL INJURY WHEN UPDATING THE MAP SOFTWARE:

If you choose to park the vehicle within range of a TCU (Telematics Control Unit) or a Wi-Fi connection (if so equipped), park the vehicle in a secure, safe well-ventilated location that is open to the air. During the update process, if you choose to park your vehicle, it should be kept in a well-ventilated area to avoid exposure to carbon monoxide. Do not breathe exhaust gases; they contain colorless and odorless carbon monoxide. Carbon monoxide is dangerous. It can cause unconsciousness or death.

1. Apply the parking brake.
2. Remain with the vehicle while the update is in process.
3. Do not allow children, pets or people who may need assistance to remain in

the vehicle while the software is updating.



NOTE:

The vehicle is not required to be parked during the map update process. If the vehicle disconnects from the Wi-Fi connection (if so equipped), it will resume when the vehicle reconnects to a known Wi-Fi connection.

Navigation map data can be updated via USB memory device, Wi-Fi (if so equipped) or TCU (Telematics Control Unit).

Updating with USB memory



The navigation map data can be updated with the latest information by downloading a new map database to a USB memory device and installing it in the vehicle.

For map update, use the USB memory with the following specifications:

Supported media: USB2.0

Supported file system: FAT32

1. Push <MENU>.
2. Touch [Information] and then touch [System Information].

3. Touch [Map Update].
4. Touch [Update by USB device].
5. Touch [Save Map Information to USB].
6. Insert blank USB memory device into the USB connection port.
 -  "USB (Universal Serial Bus) connection ports and AUX (auxiliary) input jack" (page 2-7)
 -  "USB connection ports" (page 2-8)



INFO:

If data is in the USB memory, it may be deleted.

7. Touch [Start].
8. Touch [OK] after saving the map information to USB.
9. Access to the designated website with your personal computer. Download and install the map update tool in your personal computer. (Consult an INFINITI retailer for details.)
10. Download the updated data and store it in the USB memory with the map update tool.
11. Push <MENU>.

6. Navigation (if so equipped)

12. Touch [Information] and then touch [System Information].
13. Touch [Map Update].
14. Touch [Update by USB device].
15. Touch [Install Map Update from USB].
16. Insert the USB memory into the USB connection port.

A confirmation message is displayed. Confirm the contents of the message and touch [Yes].

17. Touch [OK] after completing the update.



INFO:

- The navigation system cannot be operated while the map updates.
- Map data should be updated while the engine is running to prevent discharge of the vehicle battery.

Updating using wireless LAN (Wi-Fi) (if so equipped)

The map data can be updated using the vehicle Wi-Fi connection. Wi-Fi communications can be made by using a Wi-Fi network, smartphone, etc.

"Wi-Fi Setting" (page 2-29)

1. Connect the vehicle to an available Wi-Fi network.
2. Push <MENU>.
3. Touch [Information] and then touch [System Information].
4. Touch [Map Update].
5. Touch [Update by Wi-Fi].
A confirmation message is displayed.
6. Select an area to be updated, and touch [Start Updating].
7. Touch [OK] after completing the update.



INFO:

- When the ignition switch is placed in the OFF position, the map update is suspended. When the map update is resumed, select the same area to update the map from [Update by Wi-Fi].
- When [Cancel] is displayed during the map data update, touching the key can cancel the update.
- The navigation system cannot be operated while the map updates.
- Do not turn off the power source of the smartphone while updating.

- Map data should be updated while the engine is running to prevent discharge of the vehicle battery.
- The update is done in the background, and the updates are reflected in the map data the next time the system is started.
- The download data size of Map update for one state (such as California or New York, for example) or one regional zone (such as Indiana/Michigan or Hawaii/Alaska/Guam, for example) can vary between 100 MB to 1 GB. Data size in case of updating multiple states or regional zones can be over 1 GB. Use of Wi-Fi hotspot functionality of your smartphone for Map updates may incur additional data charges from your cellular provider. Please connect to your home Wi-Fi network to avoid additional phone data charges.

Automatic map update

The map data can be updated using the TCU (Telematics Control Unit).

1. Push <MENU>.
2. Touch [Information] and then touch [System Information].

3. Touch [Map Update].
4. Touch [Map Update Settings].
5. Select an area of the map you wish update. A confirmation message is displayed. The next time you start the system, a notification message will be displayed if map data update is available.
6. When the new map data is available after the ignition switch is placed in the ON position, the pop-up message will be displayed.
7. Touch [Yes] to update the map data. If [No] is touched, the automatic map update and software update will not be available forever and user always has to update map and software manually from next time.
8. Touch [OK] after completing the update.



INFO:

The update is done in the background, and the updates are reflected in the map data the next time the system is started.

Automotive products End User License Provisions

This End-User License Agreement ("**EULA**")

is an agreement between you and TomTom International B.V. ("**TomTom**"). You agree that this EULA is enforceable. This EULA applies to your use of the TomTom Map data, software, Traffic and Travel services or any other TomTom products (together with the "**Services**").

Please read this EULA carefully. By using the Services you agree to all the terms and conditions of this EULA.

1. **GRANT OF LICENSE:** In consideration of you agreeing to abide by the terms of this EULA, TomTom hereby grants to you a non-exclusive, license to use the Services solely in connection with the vehicle. If upgrades, updates or supplements to the Services are provided the use of such upgrades or updates is governed by this EULA.
2. **RESTRICTIONS:** You are prohibited from renting, lending, public presentation, performance or broadcasting or any other kind of distribution of the Services. Other than as permitted by applicable legislation, you will not, and you will not allow any person to, copy or modify the Services or any part thereof or to reverse engineer, decompile or disassemble the Services.

3. **OWNERSHIP:** Copyright and other intellectual, industrial and/or proprietary rights to the Services are owned by TomTom and/or its suppliers. TomTom permits you to use the Services only in accordance with the terms of this EULA. All rights not specifically granted in this EULA are reserved by TomTom. To the extent applicable, you acknowledge that you have no right to have access to the Services in source code or in unlocked coding.
4. **THIRD PARTY SOFTWARE LICENSES:** The Services may make use of third party software. Notwithstanding Clauses 2 and 3, use of some third party materials included in the Software may be subject to other terms and conditions. The official copyright notices and specific license conditions of these third party software codes and algorithms are to be found via <http://www.tomtom.com>. You hereby agree to the terms and conditions for such third party software.
5. **LIMITED WARRANTY:**
 - YOU ACKNOWLEDGE THAT THE SERVICES HAVE NOT BEEN DEVELOPED TO MEET YOUR INDIVIDUAL REQUIREMENTS AND THAT

6. Navigation (if so equipped)

IT IS THEREFORE YOUR RESPONSIBILITY TO ENSURE THAT THE FACILITIES AND FUNCTIONS OF THE SERVICES MEET YOUR REQUIREMENTS. TOMTOM DOES NOT AND CANNOT WARRANT THAT THE SERVICES OPERATE UNINTERRUPTED OR ERROR-FREE. YOU SHOULD BE PARTICULARLY AWARE OF THE FACT THAT CALCULATION ERRORS MAY OCCUR WHEN USING SOFTWARE IN A NAVIGATION SYSTEM FOR INSTANCE CAUSED BY LOCAL ENVIRONMENTAL CONDITIONS AND/OR INCOMPLETE DATA.

- TO THE MAXIMUM EXTENT PERMITTED BY APPLICABLE LAW, TOMTOM AND ITS SUPPLIERS PROVIDE THE SERVICES "AS IS", AND HEREBY DISCLAIM ALL OTHER WARRANTIES AND CONDITIONS, WHETHER EXPRESS, IMPLIED OR STATUTORY, INCLUDING, BUT NOT LIMITED TO, ANY (IF ANY) IMPLIED WARRANTIES, DUTIES OR CONDITIONS OF SATISFACTORY QUALITY, OF FITNESS FOR A PARTICULAR PUR-

POSE, OF RELIABILITY OR AVAILABILITY, OF ACCURACY OR COMPLETENESS OF RESPONSES, OF RESULTS, WITH REGARD TO THE SERVICES, AND THE PROVISION OF OR FAILURE TO PROVIDE SUPPORT OR OTHER SERVICES, INFORMATION, SOFTWARE, AND RELATED CONTENT THROUGH THE SERVICES OR OTHERWISE ARISING OUT OF THE USE OF THE SERVICES.

SAFETY: THE SERVICES ARE INTENDED TO BE USED FOR PROVIDING INFORMATION AND NAVIGATION SERVICES RELATED TO YOUR JOURNEY ONLY AND ARE NOT INTENDED TO BE USED AS A SAFETY RELATED TOOL AND CANNOT WARN YOU ABOUT ALL DANGERS AND HAZARDS WITH RESPECT TO THE ROAD YOU ARE DRIVING. THEREFORE, IT REMAINS YOUR DUTY TO DRIVE IN A CAREFUL AND SAFE MANNER (PAYING ALL DUE CARE AND ATTENTION TO THE ROAD) AS WELL AS OBSERVING ALL APPLICABLE TRAFFIC REGULATIONS AND RULES. IT IS YOUR RESPONSIBILITY NOT TO USE THE SERVICES IN A MANNER THAT WOULD DISTRACT YOU FROM DRIVING SAFELY.

6. LIMITATION OF LIABILITY:

TO THE MAXIMUM EXTENT PERMITTED BY APPLICABLE LAW, NEITHER TOMTOM NOR ITS LICENSORS AND SUPPLIERS, OFFICERS, DIRECTORS OR EMPLOYEES SHALL BE LIABLE TO YOU OR TO ANY THIRD

PARTY FOR ANY DAMAGES, WHETHER DIRECT, SPECIAL, INCIDENTAL, INDIRECT OR CONSEQUENTIAL (INCLUDING BUT NOT LIMITED TO, DAMAGES FOR THE INABILITY TO USE OR ACCESS THE SERVICES, LOSS OF DATA, LOSS OF BUSINESS, LOSS OF PROFITS, BUSINESS INTERRUPTION OR THE LIKE) ARISING OUT OF OR RELATED TO THE USE OF, THE INABILITY TO USE OR ACCESS, OR OTHERWISE THE PERFORMANCE OF THE SERVICES, EVEN IF INFINITI HAS BEEN ADVISED OF THE POSSIBILITY OF SUCH DAMAGES.

TO THE EXTENT TOMTOM IS NOT PERMITTED UNDER APPLICABLE LAW TO EXCLUDE ITS LIABILITY PURSUANT TO CLAUSE 6.1 ABOVE, TOMTOM'S TOTAL AGGREGATE LIABILITY TO YOU SHALL BE LIMITED TO THE AMOUNT OF US \$100.00.

THE ABOVE LIMITATIONS OF LIABILITY UNDER THIS CLAUSE 6 DO NOT: (I) AFFECT YOUR RIGHTS UNDER ANY APPLICABLE MANDATORY NATIONAL LEGISLATION; (II) EXCLUDE OR LIMIT ANY LIABILITY THAT CANNOT BE EXCLUDED OR LIMITED UN-

DER APPLICABLE LAW.

7. **TERMINATION:** Without prejudice to any other rights, TomTom may immediately terminate this EULA if you fail to comply with any of its terms and conditions. The provisions of this Agreement, which by their nature are intended to survive termination, will remain in effect after termination of this EULA.
8. **LINKS TO THIRD PARTY SITES:** TomTom and other third parties involved in making the Services available to you ("Third Parties") are not responsible for the contents of any third-party sites or services, any links contained in third-party sites or services, or any changes or updates to third-party sites or services which are delivered by the Services or otherwise. TomTom (and, as applicable, each of the Third Parties) is providing these links and access to third-party sites and services to you only as a convenience, and the inclusion of any link or access does not imply an endorsement by TomTom or any Third Parties of the third-party site or service. Any use by you of such links or third party sites and the manner in which you use such third party sites and links shall be your

responsibility and at your risk and you shall not use them in any illegal or fraudulent manner.

Should you have any questions concerning this EULA, or if you desire to contact TomTom for any reason, please visit TomTom's website at <http://www.tomtom.com>.

6. Navigation (if so equipped)

MEMO

7 Voice recognition

Voice recognition	7-2
Using Voice Recognition System	7-2
Before starting	7-2

Giving voice commands	7-2
System Voice settings	7-7



7. Voice recognition

VOICE RECOGNITION

USING VOICE RECOGNITION SYSTEM

Initialization

When the ignition switch is in the ON or ACC position, voice recognition is initialized. When the initialization is complete, the system is ready to accept voice commands. If <  > on the steering wheel is pushed before the initialization completes, the display will show a message to wait until the system is ready.

BEFORE STARTING

To get the best recognition performance from voice recognition, observe the following items.

- The interior of the vehicle should be as quiet as possible. Close the windows to eliminate the surrounding noises (traffic noise, vibration sounds, etc.), which may prevent the system from correctly recognizing the voice commands.
- Wait until the tone sounds before speaking a command.

- Speak in a natural conversational voice without pausing between words.
- The system cannot recognize voice commands spoken from passenger seats.

GIVING VOICE COMMANDS

1. Push <  > on the steering wheel.



Example

2. A list of commands appears on the screen, and the system provides the voice menu prompt.

Available category commands are displayed on the left side of the screen. Speak or touch a category command from the category command list.





INFO:

- Some of the commands for each category are shown on the right side of the screen and they can also be

spoken without selecting a category.

- After executing the category command, only the commands related to the selected category can be recognized.

3. After the tone sounds and the icon on the screen changes from  to , speak a command. You can also select a command by directly touching the screen, pushing <  /OK> on the steering wheel or on the INFINITI controller.



INFO:

The Voice Recognition System will pause its operation when no command is given after a few prompts. To resume the operation, push <  > on the steering wheel.

4. Continue to follow the voice menu prompts and speak the voice commands after the tone sounds until the preferred operation is executed.



INFO:

To exit the Voice Recognition System, push and hold < > or < > on the steering wheel.

Operating tips

- Speak a command after the tone.
- If the command is not recognized, the system will prompt you to speak the command again. Repeat the command in a clear voice.
- Touch [] on the touch screen or push < > on the steering wheel or the INFINITI controller to return to the previous screen.
- To adjust the volume of the system feedback, push <- +> on the steering wheel or turn <VOL/ > while the system is making an announcement.
- When setting a destination for route guidance with some search methods, such as POI, Intersection or City Center search, the search area is automatically set to the state/province where your vehicle is located. Change state/province to change the search area to another state/province if necessary.

Voice Prompt Interrupt:

In most cases, you can interrupt the voice feedback to speak the next command by pushing < > on the steering wheel. After interrupting the system, wait for a tone before speaking your command.

One Shot Call:

To use the system faster when making a call, you may speak the second level command skipping speaking the first level command. For example, push < > and say "Redial" after the tone without first saying "Phone".

For phone command operation:

- After the command "Call", a name registered in the phonebook can be spoken for recognition, while a phone number can be spoken after the command "Dial". Names from the phonebook cannot be spoken after the command "Dial".
- The system has the function to read the text messages out loud, but misreading may occur in some cases.
- Even if nicknames such as "Mom" or "Dad" are registered in the cellular phone, the Voice Recognition System recognizes only names. To have the

system recognize the nicknames, register the entries in the [Quick Dial] from the Phone menu.

"Quick Dial" (page 4-13)

For navigation command operation:

- Depending on the area where the vehicle is located (such as in Puerto Rico, Guam, etc.), the system may not recognize the general navigation commands.
- Points of Interest:
 - The POI commands searches for Points of Interest registered in the navigation system.
 - When searching for POI, the search is conducted within the current state/province or the state/province specified by "Change State" command. To change the state/province, speak "Change State" after the prompt and then after the next prompt, speak the name of the state/province for which you wish to conduct the POI search. The state/province will be reset to the current state each time the voice recognition session is re-started.

7. Voice recognition

- Not all POI main categories can be used for "Navigate to" searches with voice command operations while all registered categories can be recognized as "Nearby" search.
- Street Address:
 - Alphabet letters cannot be included when speaking a house number. When a specified house number cannot be found, a location representing the address will be displayed.
 - Speak in a natural conversational speed without pausing between words for better recognition.
 - When the system recognizes the command incorrectly, correct the search conditions using commands such as "Change State", "Change City", "Change Street" or "Change House Number".
- The Voice Recognition System may not function when the song information is too long (artist names, album titles, song titles and play lists, etc.).
- The SiriusXM® function will not operate without a subscription to SiriusXM® Radio.
- When playing USB files with the Voice Recognition System, do not pronounce the extension attached to the file name (such as ".mp3").
- Song titles registered in ID3 tags cannot be pronounced for voice recognition operation.
- Some audio command may not be recognized when an Android phone is connected and used as a USB audio device player.

For information command operation:

For audio command operation:

- Music files of Bluetooth® audio cannot be selected by voice recognition operation. However, audio source can be switched to Bluetooth® audio using voice commands.

- A SiriusXM® Travel Link (if so equipped) or SiriusXM Traffic™ (if so equipped) subscription is necessary to receive SiriusXM® information services.
☞ "SiriusXM® Travel Link"
(page 5-15)

- The TomTom Weather information cannot be operated with the voice recognition operation.

How to see voice command screen

1. Push < ⏪ > to display the first screen of the voice command list.
2. Speak a command or select an item on the voice command list. The Second screen is displayed.
3. Speak a command or select an item on the voice command list. The command is executed or the next screen for further command is displayed.
4. Follow the prompts to complete the commands.

Voice command screens:

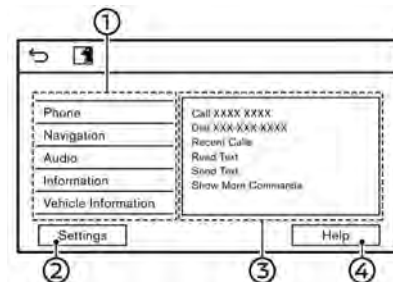

- ① Shows a list of available categories. Speak a category command or touch the key of the corresponding category.
- ② Touch [Settings] or say "Settings" to display the system voice settings.
- ③ Shows a list of available commands for the selected category. Speak a preferred command.
- ④ Touch [Help] or say "Help" to hear help announcements on how to use the system.



INFO:

Push < > to stop the help announcements.

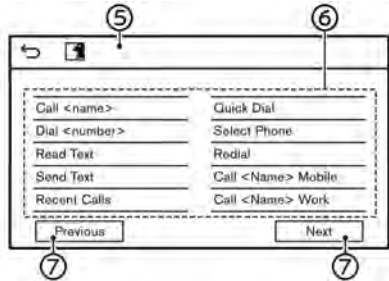

Example

- ⑤ Previously selected command
- ⑥ Command list
You can speak a command from the list or touch the corresponding key. Preferred words can be spoken for the part of the command enclosed in < >.
- ⑦ [Previous]/[Next]
Say as a command or touch to go to the previous/next screen.

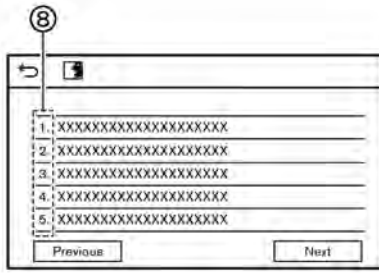

Example

- ⑧ Speak a number from 1 to 5 or touch an item on the list screen to select the item.

How to speak numbers

The Voice Recognition System requires the user to speak numbers in a certain way when giving voice commands.

General rule:

"500", "800" and "900" can be pronounced as "five hundred", "eight hundred" and "nine hundred" respectively.

For other numbers, only single digits "0" (zero) to "9" can be used. (For example, for the number "600", speaking "six zero zero" can be recognized by the system, but "six hundred" cannot be recognized.)

Example:

1-800-662-6200

"One eight hundred six six two six two zero zero"



INFO:

For the best recognition, speak "zero" for the number "0", and "oh" for the letter "o".

Voice command examples

As examples, some additional basic operations that can be performed by voice commands are described here.

Example 1 – Placing call by speaking a phone number:

7. Voice recognition

1. Push < Ⓜ > on the steering wheel.
2. Wait for the indicator to change to  .
Speak "Phone".

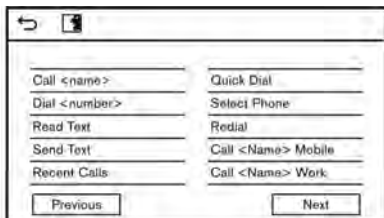

Example

3. Speak "Dial <Number>".

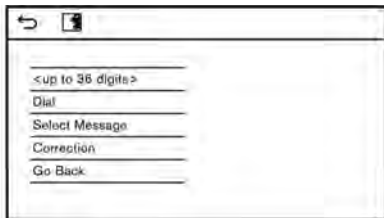

Example

4. The phone number recognized by the system is displayed on the screen. If the number is correct, say "Dial".
5. The system will make a phone call to the spoken phone number.

Example 2 – Setting home as a destination (if so equipped):

1. Push < Ⓜ > on the steering wheel.
2. Wait for the indicator change to  .
Speak "Navigation".

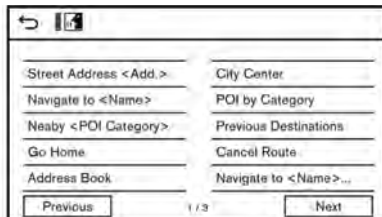

3. Speak "Go Home". The navigation system will set home as a destination.



INFO:

- Location of home must be registered to the Address Book prior to using this command.
- The step of speaking "Navigation" can be omitted.

Example 3 – Tuning station of FM:

1. Push < Ⓜ > on the steering wheel.

2. Wait for the indicator to change to  .
Speak "Audio".
3. Speak "Tune FM <name>". The system will tune to the FM radio station and the audio screen will be displayed.

SYSTEM VOICE SETTINGS

The system voice settings can be changed.

1. Push <MENU> and touch [Settings].
2. Touch [System Voice].
3. Touch a preferred item.

Available setting items may vary depending on models, specifications and software versions.

Available setting item

Setting item	Action
[Initial Voice Prompt]	When this item is turned on, voice prompts are announced.
[Short Voice Prompts]	When this item is turned on, short and minimized voice feedback will be provided.
[Best Match Lists]	When these items are turned on, the voice recognition results are displayed on the list in the order of reliable recognition.
[Phonebook] [Music Commands]	
[Voice Preference]	Voice guidance setting can be selected from a male or female voice when the system language is set to English. [Voice Preference] cannot be selected when the system is set to French or Spanish.
[Speech Rate]	Adjusts the speech rate of prompt.
[Speak Over Voice Prompts]	When this item is turned on, the driver can speak voice commands interrupting the system voice prompts.

7. Voice recognition

MEMO

8 Troubleshooting guide

Customer assistance	8-2	Bluetooth® Hands-Free Phone System	8-15
System unit	8-3	INFINITI InTouch™ Services (if so equipped)	8-19
Liquid crystal display	8-3	Apple CarPlay®	8-20
Wi-Fi connection (if so equipped)	8-4	Android Auto	8-22
Wi-Fi hotspot (if so equipped)	8-5	Siri® Eyes Free	8-24
Audio system	8-6	Navigation (if so equipped)	8-25
HD Radio technology	8-6	Basic operations	8-25
Compact Disc (CD) player	8-8	Vehicle icon	8-26
iPod® player	8-10	Route calculation and visual guidance	8-28
USB memory device	8-12	Voice guidance	8-30
Bluetooth® audio	8-13	Traffic information	8-31
		Voice recognition	8-32

8. Troubleshooting guide

CUSTOMER ASSISTANCE

For assistance or inquiries about the INFINITI Navigation System, contact the INFINITI NAVIGATION SYSTEM HELP-DESK. See the contact information on the inside front cover of this manual.

SYSTEM UNIT

LIQUID CRYSTAL DISPLAY

Symptom	Possible cause	Possible solution
The screen is too dark.	The cabin temperature is too low.	Wait until the cabin temperature becomes moderate.
	Screen brightness is set to the maximum darkness.	Adjust the brightness setting of the screen. ☞ "Display Settings" (page 2-33)
The screen is too bright.	Screen brightness is set to the maximum brightness.	Adjust the brightness setting of the screen. ☞ "Display Settings" (page 2-33)
A small black spot or a small bright spot appears on the screen.	This is a typical phenomenon for liquid crystal displays.	This is not a malfunction.
A dot or stripe pattern appears on the screen.	Electromagnetic waves that are generated from neon billboards, high voltage electric power cables, ham radios or other radio devices equipped to other vehicles may adversely affect the screen.	This is not a malfunction.
Image lag appears on the screen.	This is a typical phenomenon for liquid crystal displays.	This is not a malfunction.
Image motion displayed on the screen is slow.	The cabin temperature is less than 50°F (10°C).	Wait until the cabin temperature rises to within 50°F (10°C) and 122°F (50°C).
When looking at the screen from an angle, the screen lightens or darkens.	This is a typical phenomenon for liquid crystal displays.	Adjust the brightness setting of the screen. ☞ "Display Settings" (page 2-33)
The screen turns black or blue, or a system error message is displayed. The symptoms are not recovered after restarting the system.	A system malfunction has occurred.	It is recommended that you contact an INFINITI retailer for an inspection.

8. Troubleshooting guide

WI-FI CONNECTION (if so equipped)

Symptom	Possible cause	Possible solution
The name of the device which you wish to connect is not displayed on the Connections screen.	The device is turned off.	Check that the device is turned on.
	The device does not support a WPA2 security network.	Check that the security network is supported by the device.
The in-vehicle system cannot connect to the Wi-Fi network.	The device is turned off.	Check that the device is turned on.
	The network password is incorrect.	Check that the network password is correct.
		Check the entered password is correct.

WI-FI HOTSPOT (if so equipped)

Symptom	Possible cause	Possible solution
The device cannot connect to the vehicle Wi-Fi hotspot.	7 devices already connected.	Delete a connected device.
	The password is incorrect.	Check that the network password is correct.
		Check the entered password is correct.
The device cannot access the Internet.	The service provider's subscription is not active.	Check the service provider's subscription.
	The vehicle is out of the service area of the provider.	Move to a service supported area.
Slow connectivity to the network.	Another wireless connection interferes.	Turn off the other wireless devices.

8. Troubleshooting guide

AUDIO SYSTEM

HD RADIO TECHNOLOGY

Sound

Symptom	Possible cause	Possible solution
Delay in digital audio on HD Radio broadcasts.	The radio acquires an analog station first and blends to a digital signal.	This is not a malfunction.
Audio skips, stutters, or echoes.	The radio station has not properly aligned the digital and analog audio.	Verify correct operation on another station. Report any station with poor performance.
Volume changing up/down.	The radio station has not properly aligned digital and analog audio level.	Verify correct operation on another station and check www.hdradio.com for stations in the area. Report any station with poor performance.
Sound fading in and out.	The transition between analog and digital is taking place (blending).	Verify transition performance on several stations in the area. Report any stations with poor alignment.
Excessive blending (Transition between analog and digital).	The vehicle is located near the edge of the digital coverage area.	Refer to www.hdradio.com to verify radio stations in your coverage area.
Digital audio not better than analog audio.	Audio processing on the digital audio at a station can potentially decrease the digital audio sound quality.	Verify correct operation on another station. Report any station with poor performance.

Functional

Symptom	Possible cause	Possible solution
Keep losing my local stations.	The digital coverage is slightly less than the analog signal coverage.	Verify correct operation on another station. This is expected behavior.
	Shadowing (urban/terrain) can cause reduced digital coverage.	Verify correct operation on another station.
Some data fields are blank.	Text information is sent at the broadcaster's discretion.	Verify correct operation on another station. Report station issues.
Text information is truncated / there appears to be more available.	The display is limited to a fixed number of characters and more data is being sent than can be shown.	This is an intended behavior.
AM reception changes at night.	AM stations are required by the government (FCC) to lower their power at night.	This is not a malfunction.

8. Troubleshooting guide

COMPACT DISC (CD) PLAYER

Symptom	Possible cause	Possible solution
Music cannot be played back.	The disc is inserted upside down.	Insert a CD with the label side facing up.
	Moisture condensation occurs inside the unit.	Wait until the moisture evaporates (approximately 1 hour).
	The cabin temperature is too high.	Wait until the cabin temperature becomes moderate.
	The disc is scratched or dirty. A disc is not always playable if it is scratched.	Wipe off any dirt from the disc.
	Depending on the condition in which they are stored, discs may become unreadable due to deterioration (for example, keeping the discs in the passenger compartment, etc.).	Change the disc with a deterioration-free disc. Do not use a deteriorated disc. The label surface of the disc may crack or chip, and the layer of the label surface may eventually peel off.
The compressed audio files cannot be played back.	If both music CD files (CD-DA data) and compressed audio files (MP3 data, etc.) are mixed on one disc, the audio compression files cannot be played back.	Prepare a disc that includes compressed audio files only.
	The files are not named using characters that are compliant with the specifications.	Use the character codes and the number of characters that are compliant with the specifications for folder names and file names. In addition, always use ".MP3", ".WMA", ".mp3" or ".wma" for file extensions.
It takes a long time before the music starts playing.	The disc contains a large amount of data.	Some time may be required to check the files. It is recommended that unnecessary folders or any files other than compressed audio files should not be recorded in a disc.
The sound quality is poor.	The disc is dirty.	Wipe off any dirt from the disc.

8. Troubleshooting guide

Symptom	Possible cause	Possible solution
No sounds are played though the CD play time is displayed.	The system plays back the first track of the mix mode disc. (Mix mode is a format in which data except music is recorded on the first track and music data is recorded on one other than the first track in a session.)	Play back music data that is recorded on a track other than the first track.
Music cuts off or skips.	The combination of writing software and hardware might not match; or the writing speed, writing depth, writing width, etc. might not match the specifications.	Create a disc using different writing speed settings, etc.
The system skips the selected track and moves to the next track.	A non-MP3/WMA file is given an extension of ".MP3", ".WMA", ".mp3" or ".wma".	Prepare MP3/WMA files.
	The system plays back a file that is prohibited due to copyright protection.	Prepare playable files.
The tracks do not play back in the desired order.	The folder locations in the disc are changed by the writing software while the files are written in the disc.	Check the settings of the writing software, and create a new disc.
The CD cannot be ejected.	The ignition switch is not placed in the ACC or ON position.	Place the ignition switch in the ACC or ON position.

8. Troubleshooting guide

iPod® PLAYER

Symptom	Possible cause	Possible solution
The system does not recognize an iPod®.	A connector cable is not correctly connected, or the iPod® does not correctly operate.	Connect the connector cable again. If the system does not recognize the iPod® after performing this procedure above, reset the iPod®.
	The iPod® that is to be connected is not compatible with the system.	Check the iPod® model and iOS available for the system.
	The connected USB extension cable is not compatible with the system.	Replace the USB extension cable if the system still does not recognize the iPod® after reconnecting the cable properly a number of times.
	The cable is rapidly connected to or disconnected from the USB connection port.	Slowly connect or disconnect the USB cable.
An iPod® cannot be operated.	The iPod® is connected to the in-vehicle audio system while headsets, etc. are connected to the iPod®.	Remove all equipment from the iPod® after disconnecting the iPod® from the system, and then connect it to the system again.
	The iPod® is not operating normally.	Disconnect the iPod® from the in-vehicle audio system, and then connect it to the system again.
	The system plays back an album/file that includes a particular album art.	Disconnect the iPod® from the in-vehicle audio system, and then reset the iPod®. Disable the album art, and then connect the iPod® to the system.  "iPod® Menu" (page 3-30)
An iPod® does not respond.	There are too many files in a category.	Decrease the number of files in a category (less than 65500 files).
	The shuffle function is turned on.	Turn off the shuffle function if many files are stored on the iPod®.
Music cannot be played back.	A connector is not connected to the iPod®.	Firmly connect the connector to the iPod®.

8. Troubleshooting guide



Symptom	Possible cause	Possible solution
Playback cuts out.	The sound cuts due to vibration resulting from an unstable location of the iPod®.	Place the iPod® on a stable location where it does not roll over.
Battery charge of an iPod® takes longer.	Battery charge of the iPod® may take longer while an iPod® is playing back.	If the iPod® needs to be charged, it is recommended to stop playing the music.
Battery charge of an iPod® is unavailable.	The cable that is connected to the iPod® may be damaged or improperly connected.	Check the cable currently in use.
Functions cannot be operated using an iPod® that is connected to the in-vehicle audio system.	-	The operation of an iPod® must be performed using the in-vehicle audio system after the iPod® is connected to the system.
Sound skips.	Surrounding circumstances (noise, etc.) may cause the sound to skip.	This does not indicate a malfunction.
	A USB extension cable is used.	Do not use a USB extension cable.

8. Troubleshooting guide

USB MEMORY DEVICE

Symptom	Possible cause	Possible solution
The system does not recognize a USB device.	A USB extension cable is used.	Do not use a USB extension cable.
	A USB hub is used.	Do not use a USB hub.
	A USB device is rapidly connected to or disconnected from the USB connection port.	Slowly connect or disconnect the USB device.

BLUETOOTH® AUDIO

Symptom	Possible cause	Possible solution
Registration cannot be performed.	The Bluetooth® audio device is not compatible with the in-vehicle audio system.	Check the Bluetooth® audio device Owner's Manual.
	Bluetooth® is disabled on device.	Check that the Bluetooth® function is enabled on device.
	The PIN code is incorrect.	Check the PIN code for the Bluetooth® audio device that is to be registered.
		Check that the PIN code for the Bluetooth® audio device is consistent with that for the in-vehicle audio system.
	Another Bluetooth® device is used in the vehicle.	Turn off the other Bluetooth® device until the registration is completed.
Music cannot be played back.	The Bluetooth® audio device is not compatible with the in-vehicle audio system.	Check the Bluetooth® audio device Owner's Manual.
	The system is not set to the Bluetooth® audio mode.	Display the source menu screen, and select the Bluetooth® audio mode.  "Selecting audio source" (page 3-13)
		Push <MEDIA>/<DISC-AUX> repeatedly and select the Bluetooth® audio mode.  "Audio main buttons" (page 3-11)
A Bluetooth® adapter is turned off.	Turn on a Bluetooth® adapter when it is used for a Bluetooth® audio device.	



8. Troubleshooting guide

Symptom	Possible cause	Possible solution
Playback stops.	The Bluetooth® audio device is not compatible with the in-vehicle audio system.	Visit www.infiniti.com/bluetooth/ to check Bluetooth® audio device compatibility.
	A cellular call is active.	This is not a malfunction.
	Sound may cut out when a Bluetooth® audio device is operated.	Push <MEDIA>/<DISC-AUX> repeatedly and select the Bluetooth® audio mode, and then operate a function on the touch screen display of the in-vehicle system instead of conducting the operation on the Bluetooth® audio device.
Audio operation cannot be performed.	A Bluetooth® audio device that does not support audio operations is in use.	Visit www.infiniti.com/bluetooth/ to check Bluetooth® audio device compatibility.
	An error occurs when connecting to a Bluetooth® audio profile.	Turn the power source of the Bluetooth® audio player off and on, and then resume connection with the system.

BLUETOOTH® HANDS-FREE PHONE SYSTEM

Symptom	Possible cause	Possible solution
A cellular phone cannot be registered.	The cellular phone is not compatible with the in-vehicle Hands-Free Phone System.	Use a cellular phone compatible with the system. Visit www.infiniti.com/bluetooth/ to check compatibility.
	Registration of the cellular phone has been performed incorrectly.	Check the registration procedure, and then register the cellular phone again.
A cellular phone cannot be connected or is disconnected after the registration is completed.	The Bluetooth® setting of the in-vehicle Hands-Free Phone System is turned off.	Turn on the Bluetooth® setting of the system.
	The Bluetooth® setting of the cellular phone is turned off.	Turn on the Bluetooth® setting of the cellular phone.
	The remaining battery level of the cellular phone is low.	Charge the battery of the cellular phone.
	The wireless Bluetooth® connection may be disrupted depending on the location of the cellular phone.	Do not place the cellular phone in an area surrounded by metal or far away from the in-vehicle Hands-Free Phone System. Do not place the cellular phone close to the seats or your body.
	Registration of the cellular phone is not completed.	Perform registration of the cellular phone.
A call to a particular phone number fails.	If the system tries to make a call several times to the same phone number (for example: the party does not respond to the call, the party is out of the service area, or the call is abandoned before the party responds), the system may reject a request to make a call to the phone number.	Turn off the cellular phone and turn it on again to reset the connection.

8. Troubleshooting guide

Symptom	Possible cause	Possible solution
The system does not recognize the connection of a cellular phone. The system does not receive or make a call.	The cellular phone is not compatible with the in-vehicle Hands-Free Phone System.	Use a cellular phone compatible with the system. Visit www.infiniti.com/bluetooth/ to check compatibility.
	The cellular phone is not connected.	Check the registration procedure, and then register the cellular phone again.
	The phone operation is limited by the functions (such as dial lock, etc.) of the registered cellular phone.	Remove any settings that are limiting use of the cellular phone, and then perform registration again.
The other party cannot hear your voice. The other party can hear your voice, but it cracks or cuts out.	Mute function is enabled.	Verify mute function is disabled.
	The cellular phone is not connected.	Check the registration procedure, and then register the cellular phone again.
	The fan speed of the heater/air conditioner is too fast.	Decrease the fan speed of the heater/air conditioner.
	The ambient noise level is excessive. (For example: heavy rain, construction sites, inside a tunnel, oncoming vehicles, etc.)	Close the windows to shut out ambient noise.
	The noise generated by driving the vehicle is too loud.	Reduce the vehicle speed.
	The incoming voice volume is too loud/soft.	Adjust the volume using <VOL/  > or <-  +> on the steering wheel.
	The outgoing voice volume is too loud/soft.	Adjust the volume from volume adjustment screen.  "Volume and Beeps settings" (page 2-31)
The voice is cut out or noise is heard during a call.	The wireless Bluetooth® connection may be disrupted depending on the location of the cellular phone.	Do not place the cellular phone in an area surrounded by metal or far away from the in-vehicle Hands-Free Phone System. Do not place a cellular phone close to the seats or your body.





8. Troubleshooting guide

Symptom	Possible cause	Possible solution
When a cellular phone is operated to make a call, the hands-free function becomes unavailable.	Some models of a cellular phone do not switch to the hands-free mode when they are operated to make a call.	This is not a malfunction. Make another call using the hands-free function.
The other party's voice cannot be heard. There is no ringtone.	The volume level is set to the minimum.	Adjust the volume level.  "Volume and Beeps settings" (page 2-31)
	A cellular phone is not connected.	Check the registration procedure, and then register the cellular phone again.
Each volume level (ringtone, incoming voice or outgoing voice) is different.	Each volume level is not adjusted properly.	Adjust each volume level properly.
The antenna display and remaining battery level are different between the touch screen display and a cellular phone screen. Making or receiving a call is unavailable even though the antenna display shows that it is possible to do so.	The antenna display varies depending on the model of cellular phone.	This does not indicate a malfunction. The antenna display and remaining battery level shown on the touch screen display may be different from those shown on the cellular phone screen. Use them as a reference.
A voice cannot be heard clearly when using a cellular phone behind tall buildings.	Some structures such as tall buildings, etc. may cause irregular reflection of radio waves or completely shut out radio waves that are used for cellular phones.	Move to a place without tall buildings.
Noise is heard when using a cellular phone under/near areas of elevated railroads, high voltage electric power cables, traffic signals, neon billboards, etc.	Electromagnetic waves that are generated from radio devices may adversely affect the cellular phone.	This is not a malfunction.
Noise is heard in the sound from the audio system while using a cellular phone.	Radio waves that are generated from a cellular phone may adversely affect the sound from the audio system.	This is not a malfunction.
Sound skips or stutters.	The cellular phone may have turned on the wireless LAN (Wi-Fi).	Turn off the wireless LAN (Wi-Fi).

8. Troubleshooting guide







Symptom	Possible cause	Possible solution
Phonebook cannot be downloaded.	An error occurred during the phone pairing process.	Please delete the Bluetooth® pairing information from both the cellular phone and vehicle system before registering it again.
	Phone does not support phonebook download function.	Visit www.infiniti.com/bluetooth/ to check compatibility.

INFINITI INTOUCH™ SERVICES (if so equipped)

Symptom	Possible cause	Possible solution
The system cannot connect to the INFINITI InTouch™ Services Data Center.	A subscription for the INFINITI InTouch™ Services has not been established.	Sign up for a subscription to the INFINITI InTouch™ Services. For details about subscriptions, contact the INFINITI InTouch™ Services support line at 1-855-444-7244.  "INFINITI InTouch™ Services features" (page 5-8)
	The communication line is busy.	Try again after a short period of time.
	The vehicle is in a location where it is difficult to receive radio waves.	When the vehicle moves to an area where radio waves can be transmitted sufficiently, communication will be restored. When the icon on the display shows that the vehicle is inside the communication area, the system can be used.
	TCU (Telematics Control Unit) is not turned on.	If the antenna icon does not show that the vehicle is inside the communication area despite the fact that the vehicle is in that location, contact the INFINITI InTouch™ Services support line at 1-855-444-7244.  "INFINITI InTouch™ Services features" (page 5-8)
	Radio wave reception is not sufficient for TCU (Telematics Control Unit) operation.	When the vehicle moves to an area where radio waves can be transmitted sufficiently, communication will be restored. When the icon on the display shows that the vehicle is inside the communication area, the system can be used.
Some of the items that are displayed on the menu screen cannot be selected.	The vehicle is being driven and some menu items are disabled.	Stop the vehicle in a safe location and apply the parking brake before operating the menu screen items.
Some parts of the screen are not displayed.	The vehicle is being driven and some menu items are disabled.	Operate the system after stopping the vehicle in a safe location and applying the parking brake.
The system does not announce information.	The volume level is set to the minimum.	Adjust the volume level by operating <VOL/  > on the control panel or <-  +> on the steering wheel while the system is announcing information.

8. Troubleshooting guide

Apple CarPlay®





Symptom	Cause and Countermeasure
Cannot start Apple CarPlay® though it is tethered to the vehicle.	The USB cable is not connected to the USB connection port. Properly connect the USB cable to the USB connection port.  "USB (Universal Serial Bus) connection ports and AUX (auxiliary) input jack" (page 2-7)  "USB connection ports" (page 2-8)
	Use an Apple Lightning™ cable (Mfi certified) to connect your phone to the USB connection port and check the cable that is not broken.
	[Start-up Options] is set to [Never Start]. Change the setting to [Auto] or [Ask Every Time].  "Apple CarPlay® settings" (page 5-21)
	Apple CarPlay® setting is not active on your iPhone®. Turn on "CarPlay" on your iPhone®.
	The device is not compatible with Apple CarPlay®. Check the compatibility requirements.
Cannot use wireless Apple CarPlay® (if so equipped).	The wireless connection is not completed properly. To activate wireless Apple CarPlay®, touch  on the Connections settings screen.  "Connections settings" (page 2-27)
	The wireless connection is not completed properly.  "Connecting iPhone®" (page 5-18) Delete the iPhone® on the Devices list and reconnect it to the in-vehicle system.  "Setting devices" (page 2-27)

8. Troubleshooting guide



Apple CarPlay® performance decreases. For example, slow connectivity or slow application functionality. or An error message appears when trying to access features of Apple CarPlay®. A blank screen appears when trying to access maps.	Confirm you have a compatible iPhone®, a cellular connection and an active data plan.
	Use an Apple Lightning™ cable (Mfi certified) to connect your phone to the USB connection port.
	Phone's performance or cellular connection. Disconnect and reconnect your phone.
Cannot access Siri® using < Ⓜ > on the steering wheel.	Phone's performance or cellular connection. Cycle phone power off/on to restart.
	The USB cable may not be properly connected. Disconnect and reconnect the USB cable.
	Siri® setting is not enabled on the phone. Turn on "Siri" on your phone.
	Check that you are pushing and holding < Ⓜ > instead of just pushing the switch to initiate Siri® operation.

8. Troubleshooting guide

Android Auto



Symptom	Cause and Countermeasure
Cannot start Android Auto though it is connected to the vehicle.	The USB cable is not connected to the USB connection port. Properly connect the USB cable to the USB connection port.  "USB (Universal Serial Bus) connection ports and AUX (auxiliary) input jack" (page 2-7)  "USB connection ports" (page 2-8)
	[Start-up Options] is set to [Never Start]. Change the setting to [Auto] or [Ask Every Time].  "Android Auto settings" (page 5-25)
	To activate Android Auto, push <MENU> and touch [Android Auto], or touch [Apps] on the information screen and then touch [Android Auto].  "Information menu" (page 5-2)
	The connected device is not compatible with Android Auto. Check the compatibility requirements.
	Your Android phone may not be recognized if its battery is low. Charge your Android phone then try again.
Android Auto performance decreases. For example, slow connectivity or slow application functionality. or An error message appears when trying to access features of Android Auto. A blank screen appears when trying to access maps.	Confirm you have a compatible Android phone, a cellular connection and an active data plan.
	Use the Android phone OEM cable to connect your phone to the USB connection port.
	Phone's performance or cellular connection. Disconnect and reconnect your phone.
	Phone's performance or cellular connection. Close all apps and restart them.
Phone's performance or cellular connection. Cycle phone power off/on to restart.	

8. Troubleshooting guide

Cannot start voice operation using <  > on the steering wheel.	The USB cable may not be properly connected. Disconnect and reconnect the USB cable.
	Voice operation cannot be performed while driving. Turn on the "While driving" setting on your Android phone.
	Check that you are pushing and holding <  > instead of just pushing the switch to voice operation.



8. Troubleshooting guide

SIRI® EYES FREE

Symptom	Cause and Countermeasure
Cannot access Siri® Eyes Free using  on the steering wheel.	Check if a Bluetooth® connection is established between the iPhone® and the system.
	Check if Siri® is enabled on the device. On your phone, go to Siri® setting.
	Check that Siri® can be accessed from the device lock screen. This can be set in the settings menu of your phone.
Audio source does not change automatically to iPod® or Bluetooth® Audio mode.	For best results, use the native music app. Performance of music control function while using Podcasts, Audiobook or other third party music apps may vary.
	For best results, play media already stored on your device. Streaming music or playback from cloud storage may degrade performance.
	Switch the source manually.  "Selecting audio source" (page 3-13)
Play, pause, next track, previous track or play timer does not work.	For best results, use the native music app. Performance of music control function while using Podcasts, Audiobook or other third party music apps may vary and is controlled by the device.
Cannot hear any music/audio being played back from a connected iPhone®.	Check that the audio source is set to Bluetooth® Audio or iPod® mode. A USB connection is required for iPod® mode.
Cannot hear map turn-by-turn direction guidance from a connected iPhone®.	Check that the audio source is set to Bluetooth® Audio or iPod® mode. A USB connection is required for iPod® mode.
Cannot receive text message notifications on the vehicle audio system.	Check if "Show Notifications" is enabled on your phone.
Cannot reply to text message notifications using Siri® Eyes Free.	After receiving an incoming text message, follow the on-screen guidance. Push and hold  on the steering wheel for Siri® Eyes Free operation. After Siri® Eyes Free starts, speak an appropriate command to reply to the message using Siri® Eyes Free.



NAVIGATION (if so equipped)

BASIC OPERATIONS



Symptom	Possible cause	Possible solution
No image is displayed.	The brightness is at the lowest setting.	Adjust the brightness of the display.  "Display Settings" (page 2-33)
	The display is turned off.	Take one of the following actions to turn on the display. <ul style="list-style-type: none"> ● Push and hold <MENU>. ● Push and hold <CAMERA  * / > (models with Around View® Monitor system) / < * / > (models without Around View® Monitor system).
The volume of the voice guidance is too high or too low.	The volume is not set correctly, or the voice guidance setting is turned off.	Adjust the volume of the voice guidance or turn on the voice guidance setting.  "Volume and Beeps settings" (page 2-31)
No map is displayed on the screen.	A screen other than a map screen is displayed.	Push <MAP/VOICE> on the INFINITI controller.
The screen is too dim. The movement is slow.	The temperature in the interior of the vehicle is low.	Wait until the interior of the vehicle has warmed up.
Some pixels in the display are darker or brighter than others.	This condition is an inherent characteristic of liquid crystal displays.	This is not a malfunction.
Some menu items cannot be selected.	Some menu items become unavailable while the vehicle is driven.	Park the vehicle in a safe location, and then operate the navigation system.

8. Troubleshooting guide

VEHICLE ICON

Symptom	Possible cause	Possible solution
Names of roads and locations differ between 2D and 3D view.	This is because the quantity of the displayed information is reduced so that the screen does not become too cluttered. There is also a chance that names of the roads or locations may be displayed multiple times, and the names appearing on the screen may be different because of a processing procedure.	This is not a malfunction.
The location of the vehicle icon is misaligned from the actual position.	The vehicle was transported after the ignition switch was placed in the OFF position, for example, by a ferry or car transporter.	Drive the vehicle for a period of time on a road where GPS signals can be received.
	The position and direction of the vehicle icon may be incorrect depending on the driving environments and the levels of positioning accuracy of the navigation system.	This is not a malfunction. Drive the vehicle for a period of time to automatically correct the position and direction of the vehicle icon.  "Current vehicle location" (page 6-55)
	Driving with tire chains or tires that have been replaced may result in an incorrect vehicle location display due to miscalculation by the speed sensor.	Drive the vehicle for a period of time (at approximately 19 MPH (30 km/h) for about 30 minutes) to automatically correct the vehicle icon position. If this does not correct the vehicle icon position, it is recommended you contact an INFINITI retailer.
	The map data has a mistake or is incomplete (the vehicle icon position is always misaligned in the same area).	Updated road information will be included in the next version of the map data.  "How to update map data" (page 6-61)
When the vehicle is traveling on a new road, the vehicle icon is located on another road nearby.	Because the new road is not stored in the map data, the system automatically places the vehicle icon on the nearest road available.	Updated road information will be included in the next version of the map data.  "How to update map data" (page 6-61)

8. Troubleshooting guide

Symptom	Possible cause	Possible solution
The screen does not switch to the night screen even after turning on the headlights.	The daytime screen was set the last time the headlights were turned on.	Set the screen to the night screen mode using <CAMERA  * / > (models with Around View® Monitor system) / < * / > (models without Around View® Monitor system) when turning on the headlights.  "Display Settings" (page 2-33)
The map does not scroll even when the vehicle is moving.	The current location map screen is not displayed.	Push <MAP/VOICE> on the INFINITI controller.
The vehicle icon is not displayed.	The current location map screen is not displayed.	Push <MAP/VOICE> on the INFINITI controller.

8. Troubleshooting guide

ROUTE CALCULATION AND VISUAL GUIDANCE

Symptom	Possible cause	Possible solution
Waypoints are not included in the auto reroute calculation.	Waypoints that have been already passed are not included in the auto reroute calculation.	To go to that waypoint again, edit the route.
Route information is not displayed.	Route calculation has not yet been performed.	Set the destination and perform route calculation.
	The vehicle is not on the suggested route.	Drive on the suggested route.
	Route guidance is turned off.	Turn on route guidance.
	Route information is not provided for certain types of roads.	This is not a malfunction.
The auto reroute calculation (or detour calculation) suggests the same route as the one previously suggested.	Route calculations took priority conditions into consideration, but the same route was calculated.	This is not a malfunction.
A waypoint cannot be added.	A maximum waypoints are already set on the route, including ones that the vehicle has already passed.	To go to more waypoints, perform route calculations multiple times as necessary.
The suggested route is not displayed.	Roads near the destination cannot be calculated.	Reset the destination to a main or ordinary road, and recalculate the route.
	The starting point and destination are too close.	Set a more distant destination.
	The starting point and destination are too far away.	Divide the trip by selecting one or two intermediate destinations, and perform route calculations multiple times.
	There are time restricted roads (by the day of the week, by time) near the current vehicle location or destination.	Select [Ignore Restrictions] in the [Time Restricted Roads] setting.  "Route Preference" (page 6-34)
A part of the route is not displayed.	The suggested route includes narrow streets.	This is not a malfunction.

8. Troubleshooting guide





Symptom	Possible cause	Possible solution
The part of the route that the vehicle has already passed is deleted.	A route is managed by sections between waypoints. If the vehicle passed the first waypoint, the section between the starting point and the waypoint is deleted (it may not be deleted depending on the area).	This is not a malfunction.
An indirect route is suggested.	If there are restrictions (such as one-way streets) on roads close to the starting point or destination, the system may suggest an indirect route.	Adjust the location of the starting point or destination.
	The system may suggest an indirect route because route calculation does not take into consideration some areas such as narrow streets.	Reset the destination to a main or ordinary road, and recalculate the route.
The landmark information does not correspond to the actual information.	This may be caused by insufficient or incorrect map data.	Updated information will be included in the next version of the map data.  "How to update map data" (page 6-61)
The suggested route does not exactly connect to the starting point, waypoints or destination.	There is no data for route calculation closer to these locations.	Set the starting point, waypoints and destination on a main road, and perform route calculation.

8. Troubleshooting guide

VOICE GUIDANCE

Symptom	Possible cause	Possible solution
Voice guidance is not available.	The vehicle has deviated from the suggested route.	Go back to the suggested route or request route calculation again.
	Voice guidance is turned off.	Turn on voice guidance.
	Route guidance is turned off.	Turn on route guidance.
The guidance content does not correspond to the actual road conditions.	The content of voice guidance may vary, depending on the types of intersections at which turns are made.	Follow all traffic rules and regulations.

TRAFFIC INFORMATION

Symptom	Possible cause	Possible solution
Traffic information is not displayed.	The Premium Traffic setting is not turned on.	Turn on the Premium Traffic setting.  "Traffic information setting" (page 6-43)
	The vehicle is in an area where traffic information is not available.	Scroll to an area where traffic information is available.
	The subscription to SiriusXM Traffic™ is incomplete, or the subscription to SiriusXM Traffic™ has expired.	Check the subscription status of SiriusXM Traffic™.  "Notes on SiriusXM Traffic™ information" (page 6-40)
	The map scale is set at a level where the display of icons is impossible.	Check that the map scale is set at a level in which the display of icons is possible.  "Traffic information on map" (page 6-42)
The suggested detour route does not avoid congested areas.	There is no faster route compared to the current route, based on the road network and the traffic information.	The automatic detour search is not intended for avoiding traffic jams. It searches for the fastest route taking conditions such as traffic jams into consideration. Follow the current route.  "Notes on SiriusXM Traffic™ information" (page 6-40)
The route does not avoid a road section with traffic information stating that it is closed due to road construction.	The navigation system is designed not to avoid this event because the actual period of closure may differ from the declared roadwork period.	Observe the actual road conditions and follow the instructions on the road for a detour when necessary. If the road is closed, use the detour function and set the detour distance to avoid the road section that is closed.

8. Troubleshooting guide

VOICE RECOGNITION

Symptom	Possible cause	Possible solution
The system does not operate or fails to interpret the command correctly.	The interior of the vehicle is too noisy.	Close the windows or have the other occupants be quiet.
	The fan speed of the heater/air conditioner is too fast.	Decrease the fan speed of the heater/air conditioner.
	The noise generated by driving the vehicle is too loud.	Reduce the vehicle speed.
	The voice command is spoken in a low voice.	Speak the command in a louder voice.
	The timing of speaking a command is too early.	Speak the command after confirming the following: a voice guidance is announced, a tone sounds, and an icon on the screen changes from gray to orange.
	The command is spoken too slowly.	Speak in a natural voice without pausing between words.
The system prompts to repeat a command.	Pronunciation is unclear.	Speak clearly.
	The command is spoken too late after the tone.	Speak the command within 5 seconds after confirming the following: a voice guidance is announced, a tone sounds, and an icon on the screen changes from gray to orange.
	An improper command is spoken.	Speak the command or a number that is displayed on the screen.
		Speak a command that is shown in the command list.

8. Troubleshooting guide

Symptom	Possible cause	Possible solution
The system does not correctly recognize a number spoken.	Too many numbers are spoken at once.	Place a pause between the appropriate digits for correct recognition by the system. When speaking a telephone number, place a pause between area codes, dial codes, etc.
USB memory device cannot be operated with voice commands.	Depending on the device, iPhone® or iPod® may be recognized as a USB memory device.	This is not a malfunction.
The USB/iPod® operation screen is grayed out.	The audio device is not connected.	Connect an audio device to the system.
An error message is displayed when trying to select a track and operate USB/iPod®.	The track information is being processed for registration by the system.	Song information will be loaded into the system when a new audio device is registered for the first time or when the song information in the pre-registered device has been changed. Please wait for the loading to complete which may take a few minutes to up to an hour.
	A number of songs exceeding the amount the device can contain are stored in the connected audio device.	Decrease the number of songs stored in the audio device.
	No song is stored in the audio device.	Store songs in the connected audio device. Storing songs with information such as artist name, album name, song name, playlist, etc., will make voice recognition song search available.
The system does not correctly recognize a Point of Interest (POI) name spoken.	There are some rare cases where a POI search is unavailable by speaking the facility name but the location can be found on the map.	This is not a malfunction. Consider using an alternate search method, like street address.
	Partial or alias name is spoken.	For best results, speak the full name.

8. Troubleshooting guide

MEMO

MEMO

8. Troubleshooting guide

MEMO

Number

- 2D map 6-3
- 3D map 6-5

A

- About route guidance..... 6-27
- Adjusting settings..... 2-11
- Android Auto 5-22
- Apple CarPlay® 5-18
- Audio operation precautions..... 3-2
- Audio operations 3-12
- Audio system
 - Steering wheel audio controls 3-12
- Automatic map update 6-62
- AUX (auxiliary) input jack 2-7
- Auxiliary (AUX) devices 3-33

B

- Basic operation 2-10
- Bluetooth® audio 3-10, 3-30
- Bluetooth® Hands-Free
Phone System 4-2
- Building graphics..... 6-6

C

- Canceling route 6-33
- CD/USB memory device care
and cleaning 3-36
- Changing map..... 6-8
- Changing order of destination
and waypoints 6-38
- Changing scale of map 6-7
- Clock settings 2-31
- Compact Disc (CD) player 3-4, 3-21
- Compressed Audio
Files (MP3/WMA/AAC) 3-6
- Connecting Bluetooth®
Hands-Free Phone 4-4
- Connecting to Interactive
Voice Menu 5-12
- Connections settings 2-27
- Control buttons and functions 2-2
- Control buttons and touch
screen display 2-2
- Current vehicle location 6-55
- Customer assistance..... 8-2

D

- Deleting stored item 6-50
- Destination setting menu 6-14

- Display Settings 2-33
- Display view bar..... 2-14
- Displayed feature 2-14
- Displaying current vehicle location..... 6-6
- Displaying urgent
traffic information 6-42
- Driver Assistance settings..... 5-32
- Dual display 2-3
- During a call 4-6

E

- Editing route 6-36
- Editing stored information..... 6-47
- Editing user settings 5-29

F

- Finding address 6-18
- Finding points of interest..... 6-18
- Fully customizable
digital environment 5-29
- Functions disabled while driving 2-19

G

- Giving voice commands 7-2

H

- Hands-free text messaging assistant... 4-7
- How to handle display 2-3
- How to see voice command screen..... 7-4

I

- INFINITI controller 2-4, 2-5
- INFINITI Drive Mode Selector 5-34
- INFINITI InTouch™ Services 5-7
- INFINITI InTouch™ Services application 5-10
- INFINITI InTouch™ Services feature..... 5-8
- INFINITI InTuition 5-31
- Information menu 5-2
- InTouch Services settings..... 5-14
- iPod® player..... 3-26

L

- Laser product..... 1-4
- Licenses 1-6
- Log-in screen 2-9
- Lower display and menu buttons 2-16
- Lower touch screen display (lower display) 2-16

M

- Making a call..... 4-5
- Map types..... 6-3
- Map view settings..... 6-9
- Moving map 6-6

N

- Navigation settings 6-53
- Notes on SiriusXM Traffic™ information..... 6-40
- Number input screen 2-12

O

- One Shot Call..... 7-3
- Options before starting the route guidance..... 6-26

P

- Phone 4-4
- Phone operation 5-24
- Phone selection 4-4
- Phone settings..... 4-11

Q

- Quick Dial..... 4-13

R

- Radio 3-2, 3-14
- Recalculating route 6-36
- Receiving a call 4-5
- Route calculation 6-60
- Route guidance 6-27, 6-58
- Route options menu 6-30

S

- Safety information 1-3, 6-3
- Searching from address book 6-21
- Searching from previous destinations..... 6-20
- Setting by phone number 6-23
- Setting city center 6-22
- Setting destinations by Google 6-21
- Setting detour route 6-33
- Setting from stored routes 6-23
- Setting home as destination..... 6-17
- Setting information on map 6-13
- Setting intersection..... 6-22

Setting point on map	6-25
Setting with INFINITI InTouch™ Services	6-22
Setting work location as destination ...	6-17
Settings menu	2-21
Shortcut menu	2-12
Siri® Eyes Free	5-26
Siri® operation	5-20
SiriusXM® Travel Link	5-15
Specifying region	6-16
Split screen	6-8
Start-up screen	2-9
Starting system	2-9
Steering	
Steering wheel mounted controls for audio	3-12
Steering wheel switches	2-6
Storing a location/route	6-44
Storing avoid area	6-46
Storing home location	6-44
Storing location	6-44
Storing route	6-45
Subscription to INFINITI InTouch™ Services	5-7
System settings	2-21
System voice settings	7-7

T

Text message settings	4-11
TomTom Weather information	5-27
Touch panel	2-9
Trademarks	1-4
Traffic information on map	6-42
Traffic information setting	6-43
Turn list	6-29

U

Upper display	2-12
Upper touch screen display (upper display)	2-12
USB (Universal Serial Bus) connection port	2-7, 3-5
USB connection ports	2-8
USB memory device player	3-23
User edit screen	5-30
User registration	5-29
User selection	2-9

V

Viewing SiriusXM® Travel Link	5-15
Viewing traffic events from list	6-42
Viewing traffic information	6-40

Voice Prompt Interrupt	7-3
Voice recognition	7-2
Volume settings	2-31

Index

MEMO

MEMO

Index

MEMO

MEMO

Index

MEMO

QX50

Q50

QX55

Q60

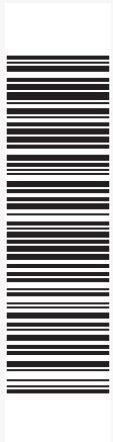

Printing : February 2022
Publication No.: N22E PVOTJU3
Printed in the U.S.A.

PVOTJ-N